

MA1

series



Product Segments

- **Industrial Motion**

TiMOTION's MA1 series linear actuator is the proven choice for applications requiring a durable, long life solution. Specifically designed for harsh working environments, the MA1 linear actuator is ideal for use in heavy-duty machinery, industrial equipment and off road vehicles. This linear actuator has been certified for applications requiring IP69K compliance. Available options for the MA1 linear actuator include AC or DC power, ball or acme spindles, mechanical or electrical braking and a load limiting clutch or limit switches.

General Features

Max. load	ACME screw: 8,000N (push/pull); Ball screw: 4,500N (push/pull)
Max. speed at max. load	5.7mm/s (ACME screw, DC motor); 14.8mm/s (Ball screw, DC motor)
Max. speed at no load	31.2mm/s (ACME screw, DC motor); 59mm/s (Ball screw, DC motor)
Retracted length	≥ Stroke + 160mm (ACME screw, without POT); ≥ Stroke + 201mm (Ball screw, without POT)
IP rating	IP69K
Certificate	UL73, EMC
Stroke	20~1000mm (ACME screw); 20~800mm (Ball screw)
Output Signals	Mechanical pot., Hall sensors*2 (5-36V input or PNP type)
Options	Overload clutch, motor brake, mechanical brake
Voltage	12/24/36/48V DC (thermal switch); 115/230V AC
Spindle	ACME or Ball screw
Color	Black
Operational temperature range	-40°C~+85°C
Operational temperature range at full performance	+5°C~+45°C
Electromagnetic brake option	
Higher duty cycle (25%), corrosion proof	
Manual drive	

Drawing

Standard Dimensions
(mm)

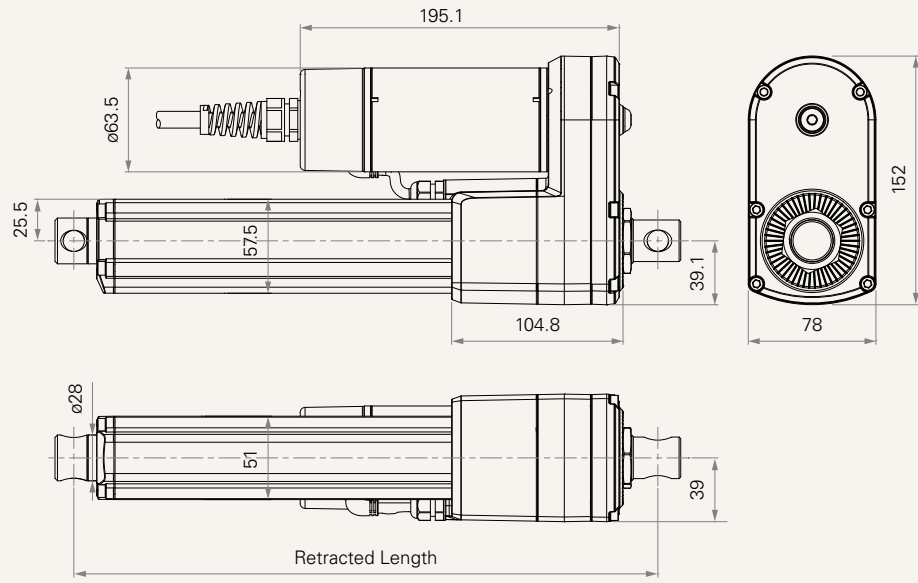

Load and Speed

Rated Load and Self-Lock Force

Spindle type	Load & speed	Load (N)		Self Lock (N)	Duty Cycle	Overload Clutch Range (N)
		Push	Pull			
ACME screw	B	1500	1500	1950	25%	2250~3000
	C	2500	2500	3250	25%	3000~5000
	D	4000	4000	5200	25%	N/A
	E	6000	6000	7800	25%	N/A
	F	8000	8000	10400	10%	N/A
Ball screw	A	2500	2500	3250	25%	3000~5000
	B	3500	3500	4550	25%	4500~7000
	C	4500	4500	5850	25%	6750~9000

Rated Current and Speed

Spindle type	Load & speed	24VDC				115VAC				230VAC			
		Typical Current (A)		Typical speed (mm/s)		Typical Current (A)		Typical speed (mm/s)		Typical Current (A)		Typical speed (mm/s)	
		No Load	With Load	No Load	With Load	No Load	With Load	No Load	With Load	No Load	With Load	No Load	With Load
ACME screw	B	Motor Speed (4100RPM)				Motor Speed (3600RPM)				Motor Speed (2900RPM)			
	C	2.5	7.50	31.2	27.4	1.7	2.0	28.0	24.7	0.8	1.0	23.5	21.0
	D	2.0	6.50	17.0	15.0	1.7	2.0	14.5	12.8	0.8	1.0	12.1	11.2
	E	3.0	9.10	17.3	14.8	-	-	-	-	-	-	-	-
	F	3.0	8.45	8.6	7.6	-	-	-	-	-	-	-	-
Ball screw	A	3.0	9.10	6.7	5.7	-	-	-	-	-	-	-	-
	A	3.5	14.0	59.0	45.0	1.8	3.0	56.5	44.7	1.0	1.3	46.0	40.0
	B	2.5	8.5	31.0	26.0	1.7	2.1	27.5	25.0	1.0	1.1	23.2	19.2
	C	2.0	6.3	16.6	14.8	1.7	2.0	14.2	13.0	1.0	1.0	12.1	11.0

Note

- 1 Please refer to the approved drawing for the final authentic value.
- 2 The self-locking force is a minimum value and can be actually higher.
- 3 The current & speed in table are tested when the actuator is extending under push load.
- 4 The current & speed in table are tested with 24V DC motor. With a 12V DC motor, the current is approximately twice the current measured in 24V DC. With a 36V DC motor, the current is approximately two-thirds the current measured in 24V DC. With a 48V DC motor, the current is approximately half the current measured in 24V DC. Speed will be similar for all the voltages.
- 5 Without load, noise level ≤ 78dBA (by TiMOTION test standard, ambient noise level ≤ 36dBA)
- 6 Standard stroke: Min. 20mm, Max. please refer to the table below.

SPINDLETYPE	CODE	Load (N)	Max Stroke (mm)
ACME	B	≤ 1500	1000
	C	≤ 2500	800
	D, E	≤ 6000	600
	F	≤ 8000	400
Ball	A	≤ 2500	800
	B, C	≤ 4500	600

Performance Data (24V DC Motor)

Motor Speed (4100RPM)

Speed vs. Load

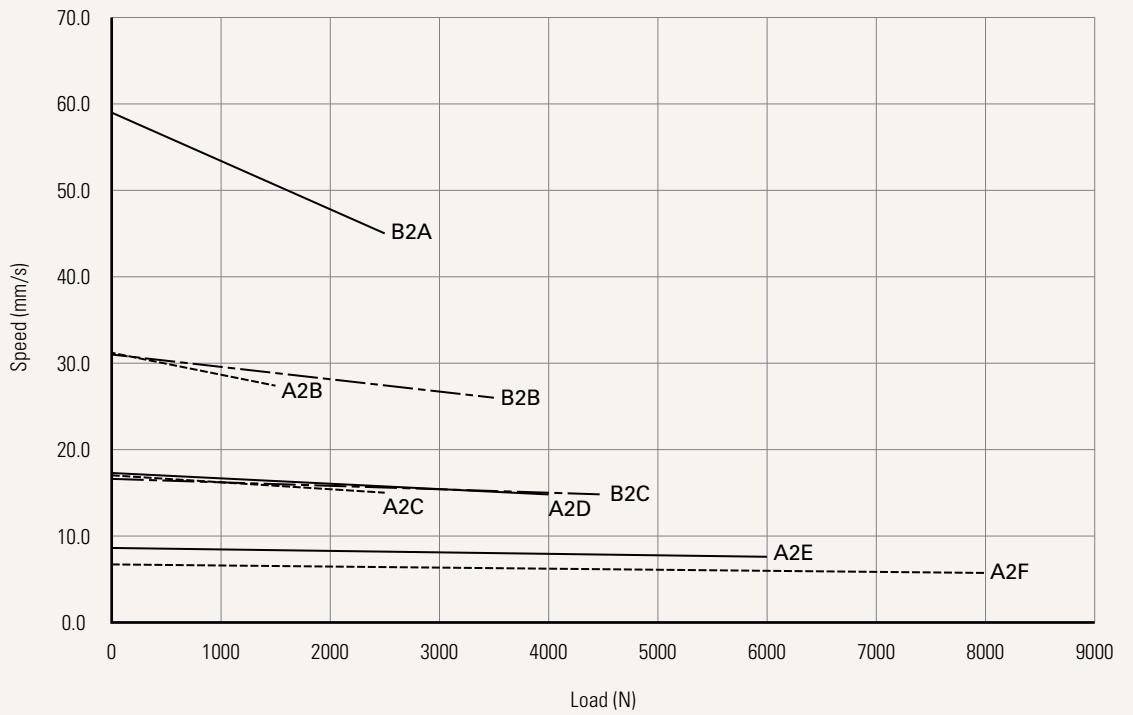

Current vs. Load

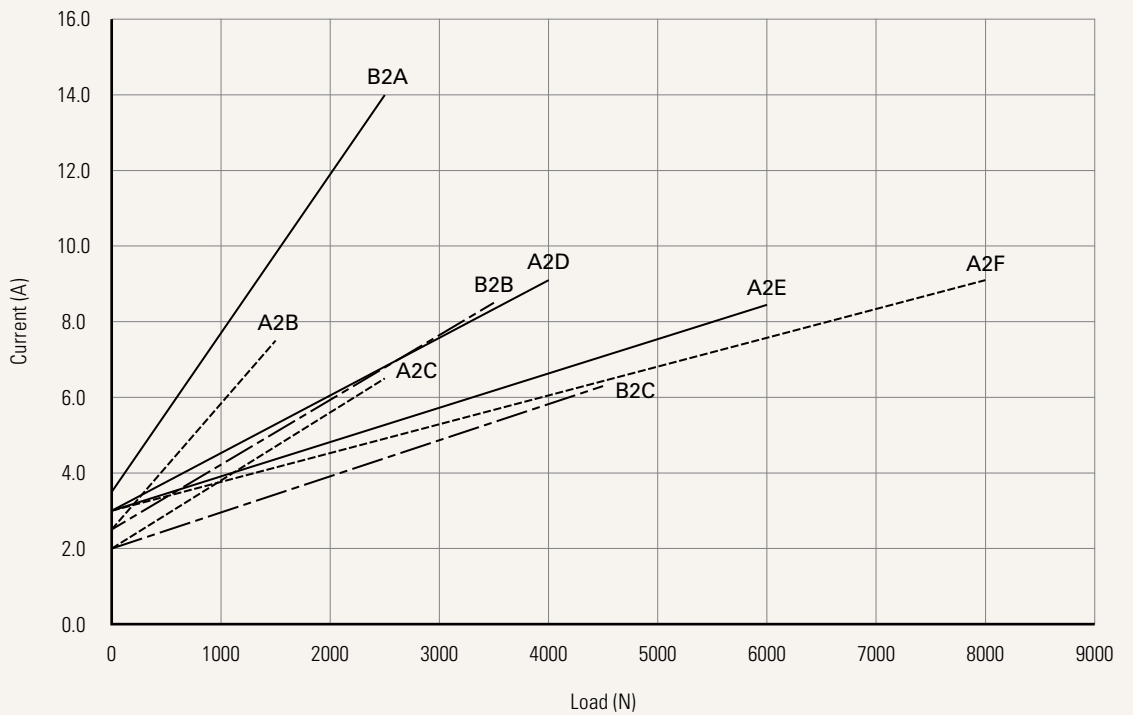

Performance Data (115V AC Motor)

Motor Speed (3600RPM)

Speed vs. Load

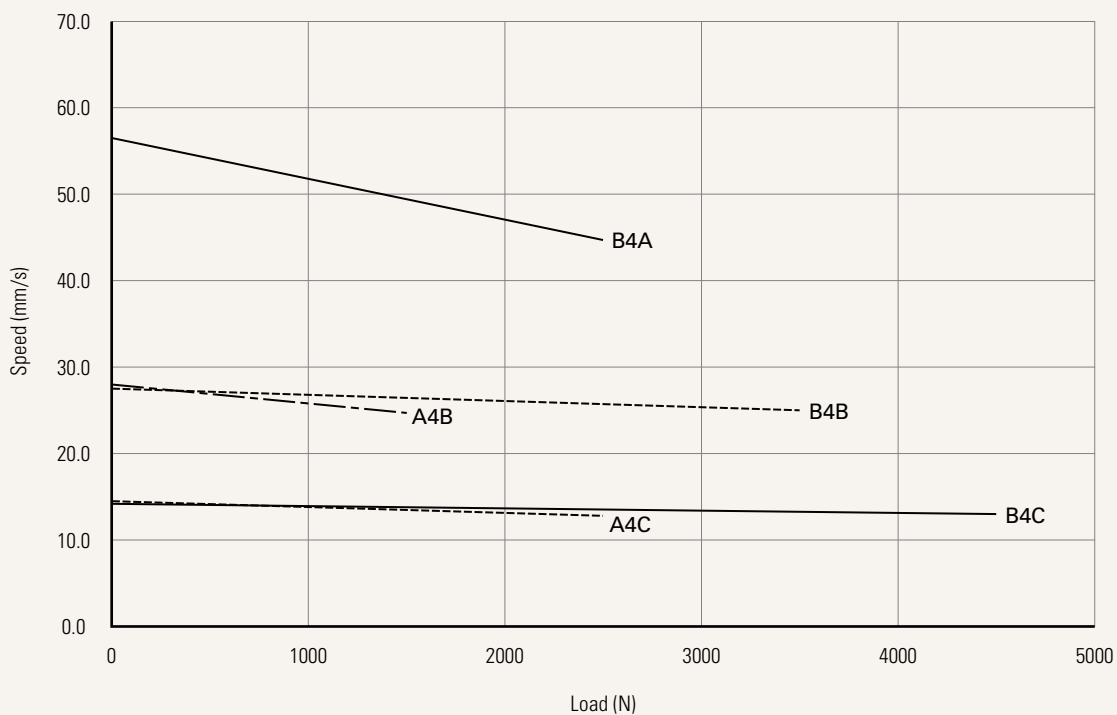

Current vs. Load

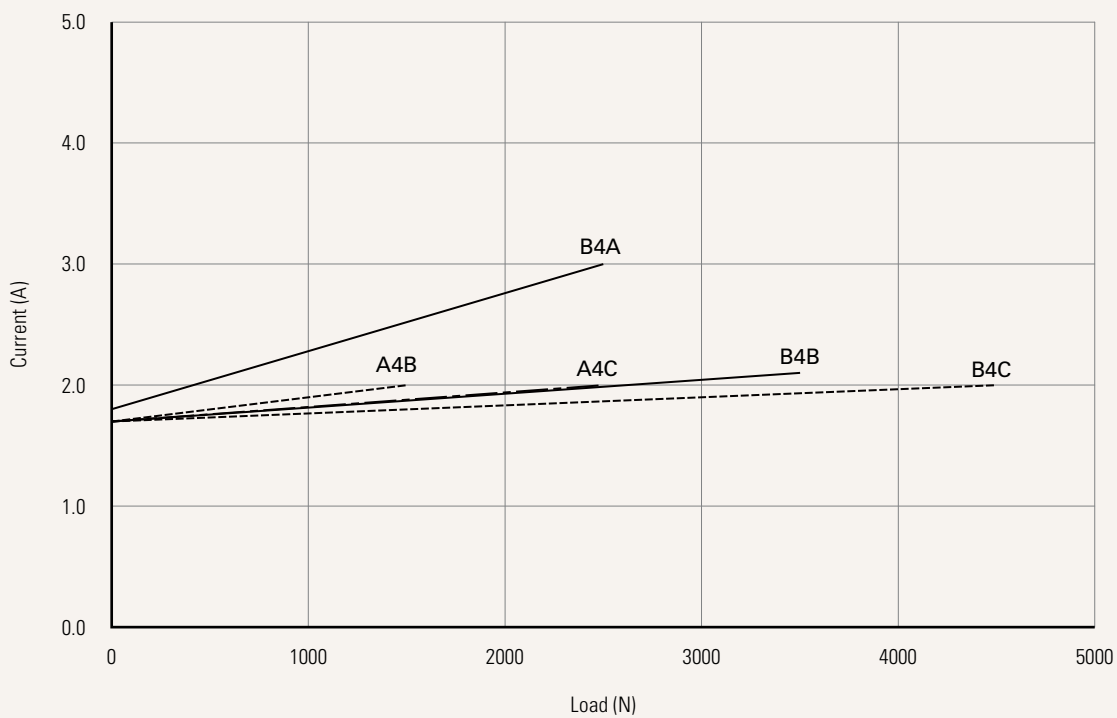

Performance Data (230V AC Motor)

Motor Speed (2900RPM)

Speed vs. Load

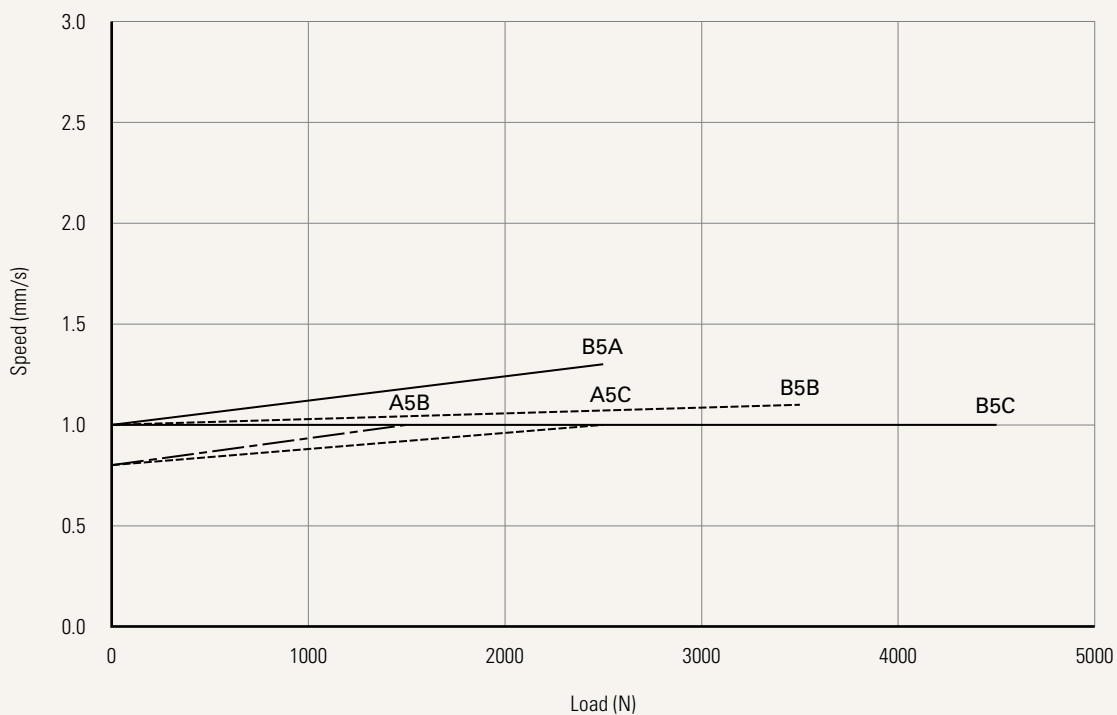

Current vs. Load

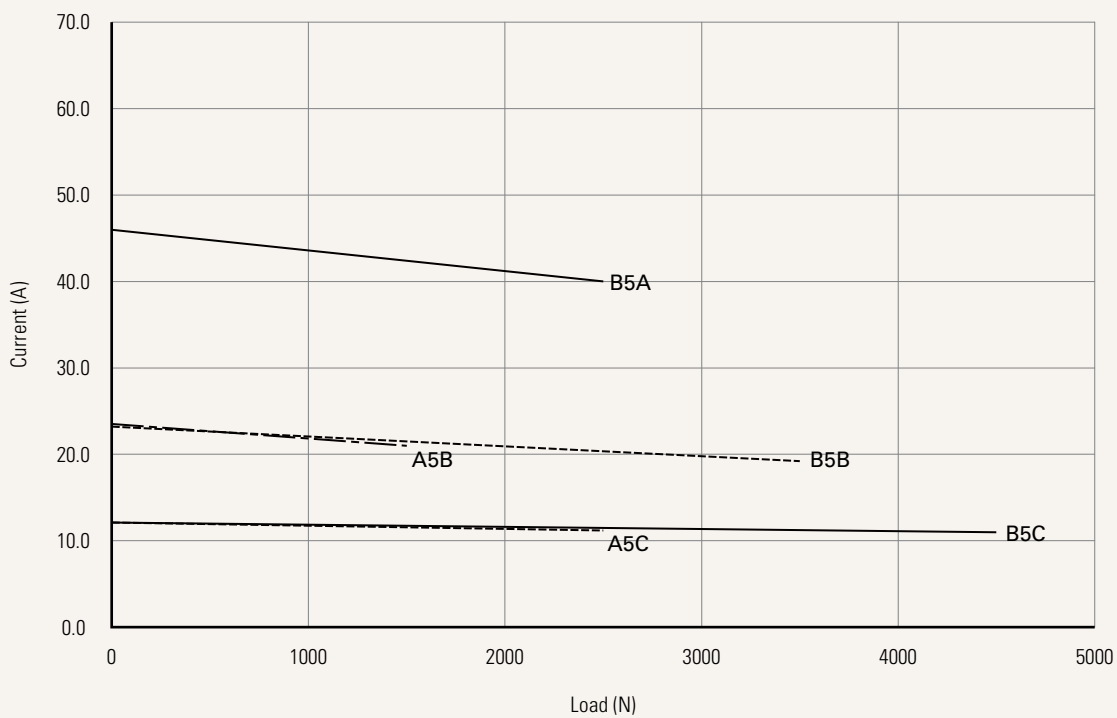

Spindle Type	A = ACME screw	B = Ball screw		
Voltage	1 = 12V DC, thermal switch	3 = 36V DC, thermal switch	4 = 115V AC 60Hz	
	2 = 24V DC, thermal switch	9 = 48V DC, thermal switch	5 = 230V AC 50Hz	
Load and Speed	See page 3			
Stroke (mm)	See page 3			
Retracted Length (mm)	See page 8			
Rear Attachment (mm)	1 = #45 Steel CNC, slotless, hole 13.0			
	See page 8			
Front Attachment (mm)	1 = #45 Steel CNC, slotless, hole 13.0			
	See page 8			
Direction of Rear Attachment (Counterclockwise)	1 = 90° (Standard)	2 = 0°		
	See page 9			
Function of Limit Switches	0 = Without (For overload clutch must choose #1_With)			
	1 = Two micro switches cut off the actuator at end of stroke			
	2 = Two micro switches send signal at end of stroke (signal type: normally closed)			
Overload Clutch	0 = Without	1 = With		
Brake	0 = Without			
	M = Motor brake (load and speed #D, E, F default option, unavailable to other load and speed options)			
	1 = Mechanical brake (ball screw's default option)			
Electromagnetic Brake	0 = Without (Standard)			
	1 = With (does not support control boxes with PWM speed adjustment functions, such as soft start/stop or synchronization)			
	See page 9			
IP Rating	6 = IP66M	8 = IP69K		
Manual Drive	1 = With			
Output Signal	0 = Without	N = Hall sensor*2 (5-36V input)		
	1 = Mechanical pot.	P = Hall sensor*2 (PNP type, 5-36V input)		
	See page 10			
Connector (mm)	1 = Tinned leads, unsheathed wire 50, stripped wire 10			
Cable Length (mm)	1 = Straight, 500	2 = Straight, 1000	3 = Straight, 1500	4 = Straight, 2000

Retracted Length (mm)

1. Calculate $A+B+C = Y$
2. Retracted length needs to \geq Stroke + Y

A. Type	
ACME	Ball
+160	+201

B. Mechanical Brake		
	ACME	Ball
0	-	-
1	+35	-

C. Output Signal				
	ACME, DC	ACME, AC	Ball, DC	Ball, AC
0	-	-	-	-
1	+36	+36	+40	+40
5	-	+36	-	+40

Rear Attachment (mm)

1 = #45 Steel CNC, without slot, hole
13.0

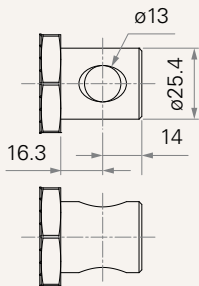

Front Attachment (mm)

1 = #45 Steel CNC, without slot, hole
13.0

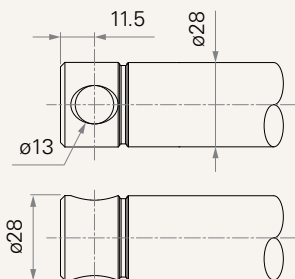

Direction of Rear Attachment (Counterclockwise)

1 = 90° (Standard)

2 = 0°

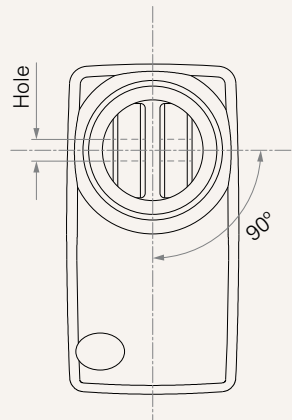
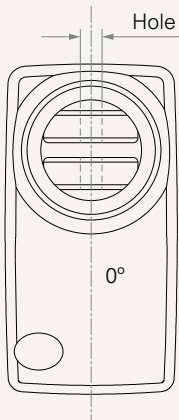

Electromagnetic Brake

0 = Without (Standard, DC)

1 = With (DC)

0 = Without (Standard, AC)

1 = With (AC)

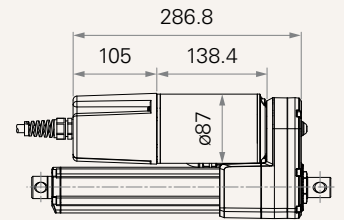
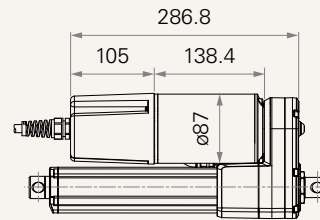
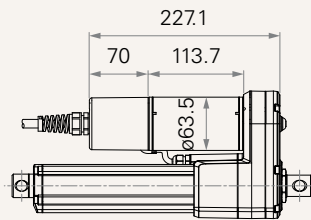
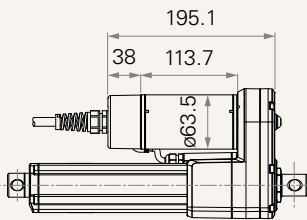

Wire Definition

DC Motor

Port	Wire Color	Wire Gauge (AWG)	Output Signal			
			0. Without	1. Mechanical pot.	5, N, P. Hall sensor*2	
Motor Exit	● BK	26	X	X	GND	
	● BU	26	X	X	S2	
	○ WH	26	X	X	S1	
	● RE	26	X	X	Vcc	
	● RE/GR	14		EXT+	EXT+	EXT+
	● BK/YE	14		RET+	RET+	RET+
Gearbox Exit	● RE	26	X	POT-Vin	X	
	○ WH	26	X	POT-Vout	X	
	● BK	26	X	POT-GND	X	

AC Motor

Port	Wire Color	Wire Gauge (AWG)	Output Signal	
			0. Without	1. Mechanical pot.
Motor Exit	● BK	18	RET+	RET+
	● GY	18	EXT+	EXT+
	● BN	18	PCBA+	PCBA+
	● BU	18	N	N
	● GR/YE	18	GND	GND
	Gearbox Exit	● RE	20	X
○ WH		20	X	pin 2
● BU		20	X	X
● BK		20	X	pin 3

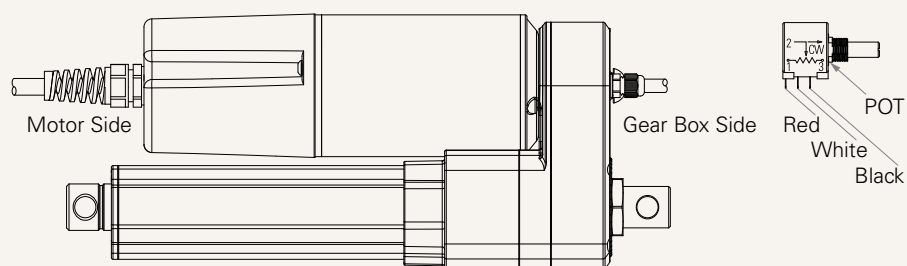

Terms of Use

The user is responsible for determining the suitability of TiMOTION products for a specific application. TiMOTION products are subject to change without prior notice.