

SR1

series

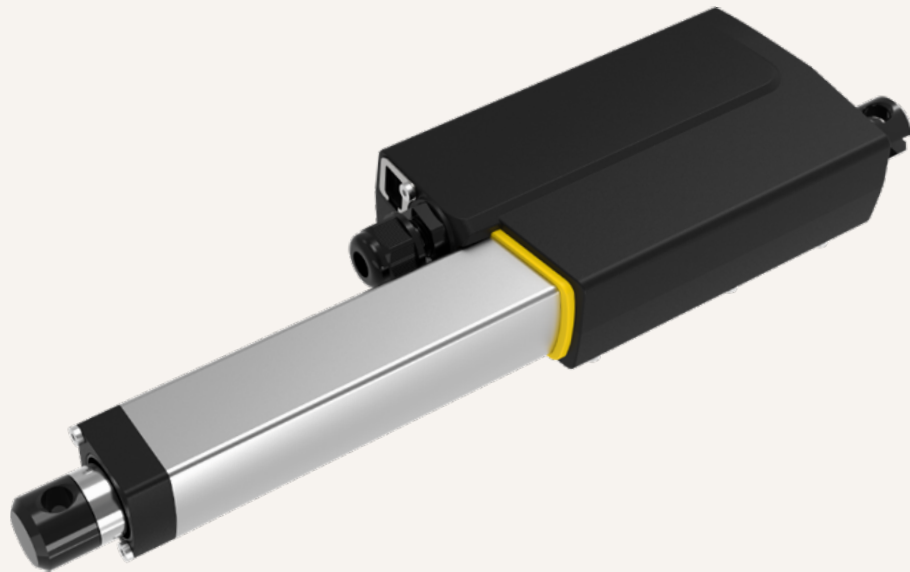

Product Segments

- **Industrial Motion**

TiMOTION's SR1 series is a low-noise industrial linear actuator specifically designed for applications requiring a resilient and quiet solution. Constructed with plastic helical gearing and a sturdy metal housing, the SR1 has a noise level lower than 58 dBA. Available with an optional IP rating of up to IP69K, suppressed noise and robust quality, it's capable of working in almost any environment. Compact, silent, and weather-resistant, the SR1 series is an ideal choice for light industrial use.

General Features

Max. load	4,000N (push/pull)
Max. speed at max. load	3mm/s
Max. speed at no load	7.4mm/s
Retracted length	≥ 230mm
IP rating	IP69K
Stroke	50~1000mm
Output signals	Mechanical pot., Hall sensors
Voltage	12/24V DC; 12/24V DC (PTC)
Operational temperature range	-25°C~+65°C
Operational temperature range at full performance	+5°C~+45°C
Low noise	

Drawing

Standard Dimensions
(mm)

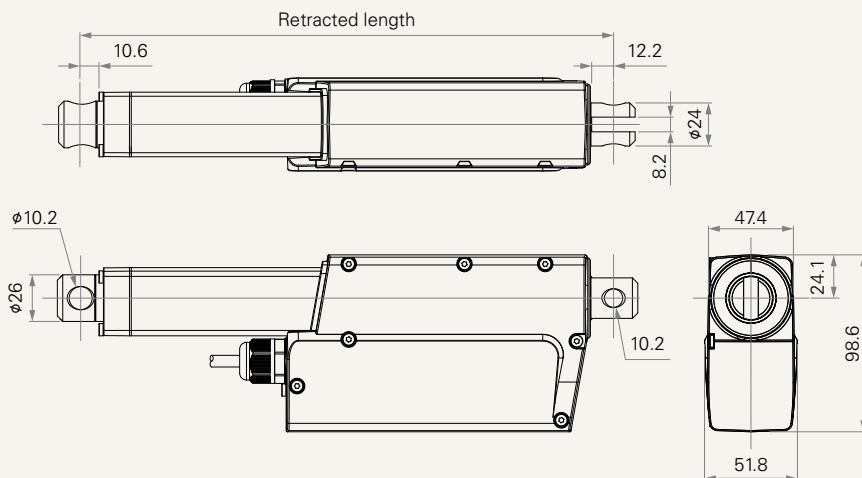

Load and Speed

CODE	Load (N)		Self Locking Force (N)	Typical Current (A)		Typical Speed (mm/s)	
	Push	Pull		No Load 24V DC	With Load 24V DC	No Load 24V DC	With Load 24V DC
Motor Speed (4800RPM, Duty Cycle 25%)							
B	2000	2000	2600	2.5	3.5	7.4	6.0
C	4000	4000	5200	2.3	3.5	3.7	3.0

Note

- 1 Please refer to the approved drawing for the final authentic value.
- 2 The current & speed in table is tested when the actuator is extending under push load.
- 3 The current & speed in table are tested with 24V DC motor. With a 12V DC motor, the current is approximately twice the current measured in 24V DC; speed will be similar for both voltages.
- 4 Without load, noise level ≤ 58 dB(A) (by TiMOTION test standard, ambient noise level ≤ 36 dB(A))
- 5 Standard stroke: Min. ≥ 50 mm, Max. please refer to the table below.

CODE	Load (N)	Max Stroke (mm)
B	≤ 500	1000
C	≤ 1000	600

Performance Data (24V DC Motor)

Motor Speed (4800RPM, Duty Cycle 25%)

Speed vs. Load

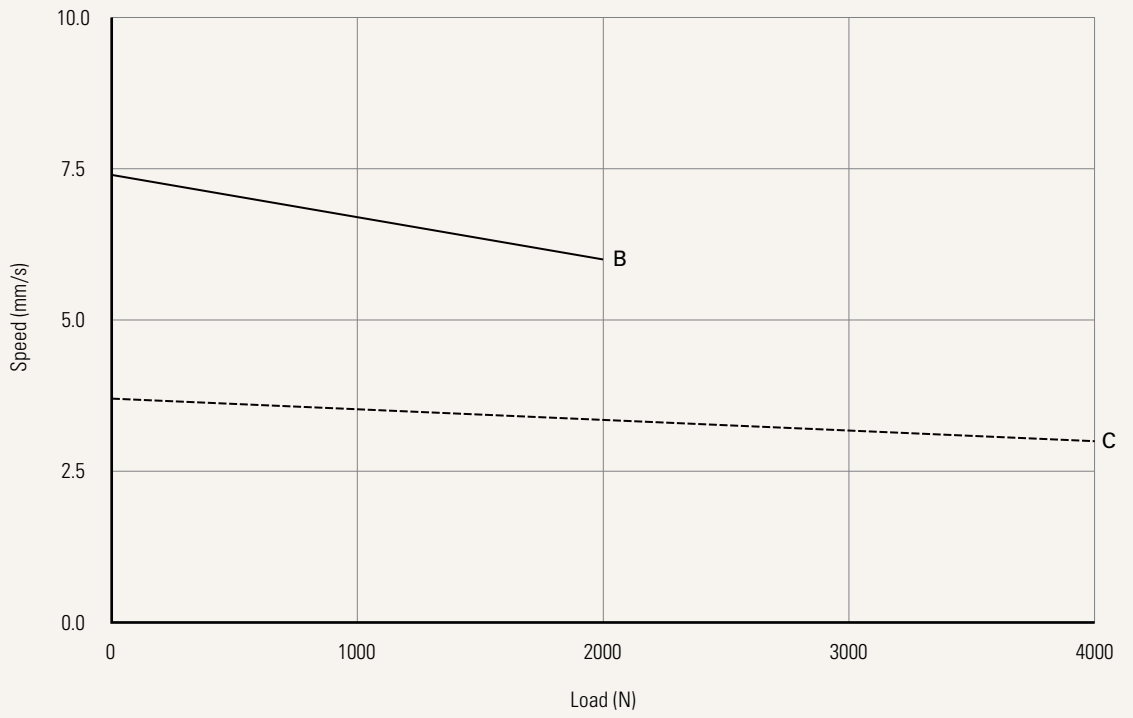

Current vs. Load

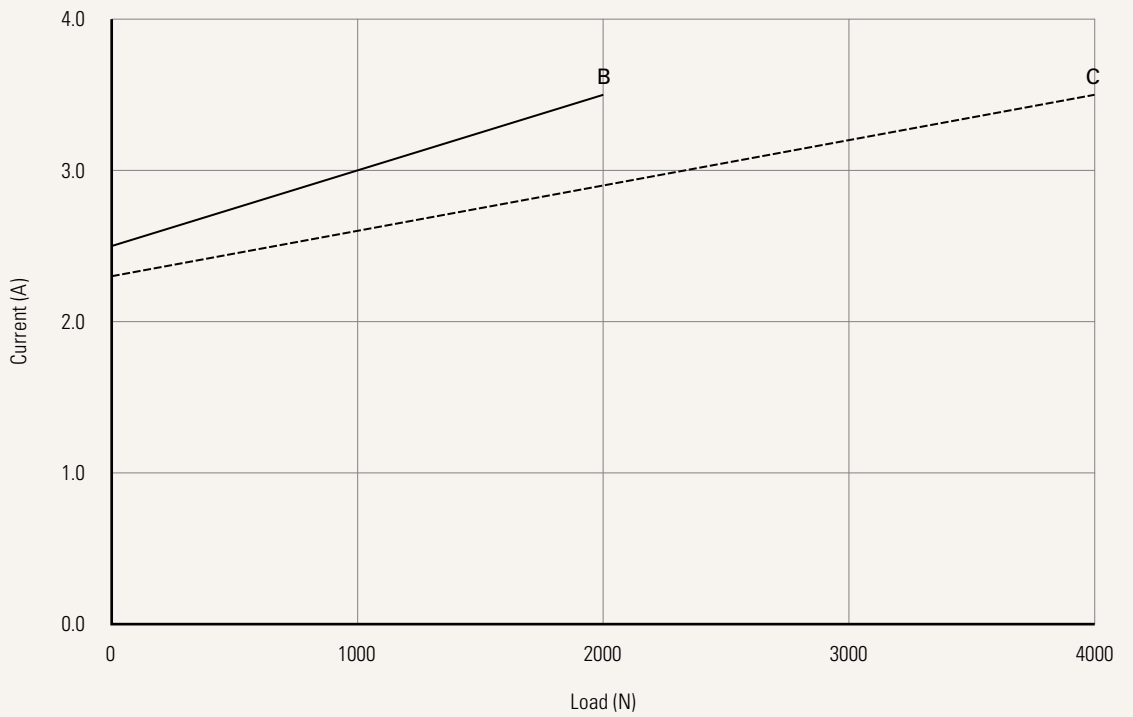

Version	N = Without T-smart			
Voltage	1 = 12V DC	2 = 24V DC	5 = 24V DC, PTC	6 = 12V DC, PTC
Load and Speed	See page 2			
Stroke (mm)	See page 2			
Retracted Length (mm)	See page 5			
Rear Attachment (mm)	1 = Aluminum, U clevis, slot 8.2, depth 12.2, hole 10.2 2 = Aluminum, U clevis, slot 8.2, depth 12.2, hole 12.2		3 = Aluminum, U clevis, slot 8.2, depth 12.2, hole 12.8	
See page 6				
Front Attachment (mm)	1 = Aluminum, slotless, hole 10.2 2 = Aluminum, slotless, hole 12.2 3 = Aluminum, slotless, hole 12.8		4 = Aluminum, U clevis, slot 8.2, depth 12.2, hole 10.2 5 = Aluminum, U clevis, slot 8.2, depth 12.2, hole 12.2 6 = Aluminum, U clevis, slot 8.2, depth 12.2, hole 12.8	
See page 6				
Direction of Rear Attachment (Counterclockwise)	2 = 0°		1 = 90°	
See page 7				
IP Rating	6 = IP66D		9 = IP69K	
Special Function of Spindle Subassembly	0 = Without (Standard)		1 = Safety nut	
Function of Limit Switches	1 = Two micro switches cut off the actuator at end of stroke			
See page 7	2 = Two micro switches cut off the actuator at end of stroke + third one in between sends signal			
	3 = Two micro switches send signal at end of stroke			
	4 = Two micro switches send signal at end of stroke + third one in between sends signal			
Output Signal	0 = Without		P = Mechanical pot. 5 = Hall sensor * 2	
Connector	2 = Tinned leads			
See page 7				
Cable Length (mm)	1 = Straight, 500mm	3 = Straight, 1000	5 = Straight, 1500	6 = Straight, 2000
Manual Drive	0 = Without			

Retracted Length (mm)

1. Calculate $A+B = Y$
2. Retracted length needs to $\geq \text{Stroke}+Y$
3. Retracted length needs to $\geq 230\text{mm}$

A. Front Attach. Load & Speed Type(N)

	B	C
Slotless	+118	+125
U clevis	+128	+135

B. Stroke (mm)

25-150	-
151-200	-
201-250	+10
251-300	+20
301-350	+30
351-400	+40
401-450	+50
451-500	+60
501-550	+70
551-600	+80

C. Output Signals

P_Mechanical Pot.	+20
--------------------------	-----

D. Spindle Set

0_Without	-
1_Safety nut	+12

Rear Attachment (mm)

1 = Aluminum, U clevis, slot 8.2, depth 12.2, hole 10.2

2 = Aluminum, U clevis, slot 8.2, depth 12.2, hole 12.2

3 = Aluminum, U clevis, slot 8.2, depth 12.2, hole 12.8

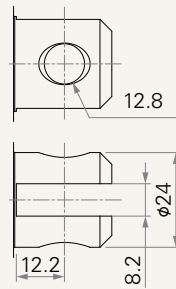
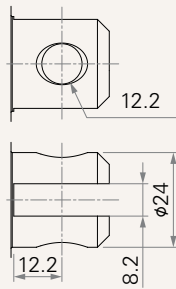
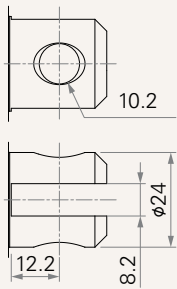

Front Attachment (mm)

1 = Aluminum, slotless, hole 10.2

2 = Aluminum, slotless, hole 12.2

3 = Aluminum, slotless, hole 12.8

4 = Aluminum, U clevis, slot 8.2, depth 12.2, hole 10.2

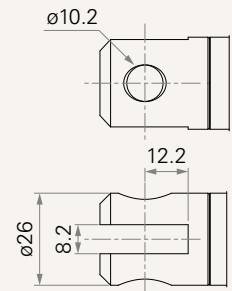
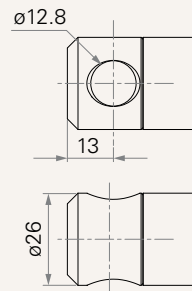
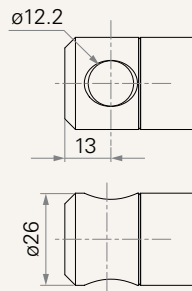
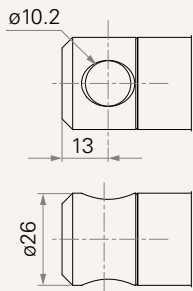

5 = Aluminum, U clevis, slot 8.2, depth 12.2, hole 12.2

6 = Aluminum, U clevis, slot 8.2, depth 12.2, hole 12.8

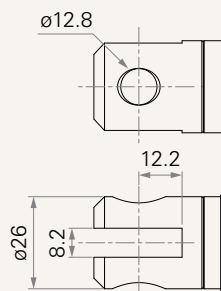
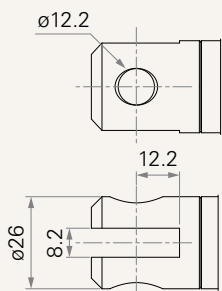

Direction of Rear Attachment (Counterclockwise)

2 = 0°

1 = 90°

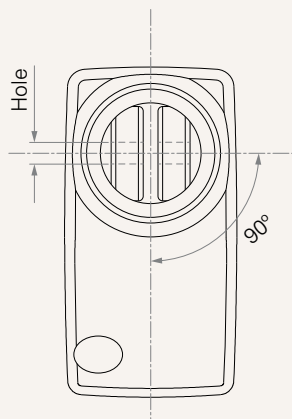
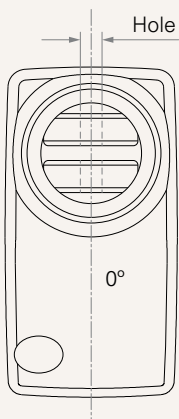

Function of Limit Switches

Wire Definitions

CODE	Pin					
	● 1 (Green)	● 2 (Red)	○ 3 (White)	● 4 (Black)	● 5 (Yellow)	● 6 (Blue)
1	extend (VDC+)	N/A	N/A	N/A	retract (VDC+)	N/A
2	extend (VDC+)	N/A	middle switch pin B	middle switch pin A	retract (VDC+)	N/A
3	extend (VDC+)	common	upper limit switch	N/A	retract (VDC+)	lower limit switch
4	extend (VDC+)	common	upper limit switch	medium limit switch	retract (VDC+)	lower limit switch

Connector

2 = Tinned leads



Terms of Use

The user is responsible for determining the suitability of TiMOTION products for a specific application. TiMOTION products are subject to change without prior notice.