

# TA41

series

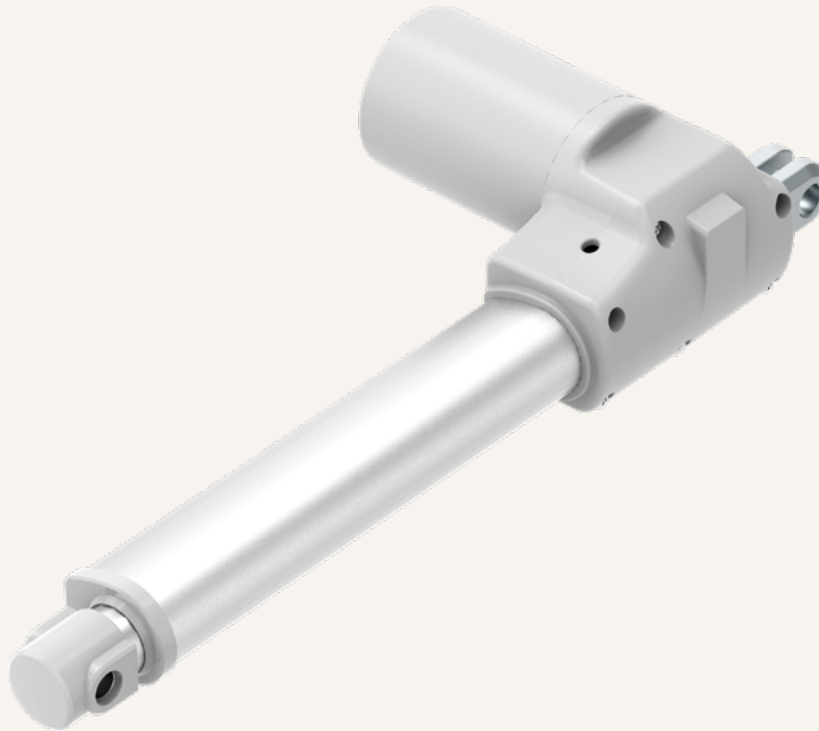

## Product Segments

- **Care Motion**

TiMOTION's TA41 is the ideal linear actuator for medical applications, particularly for dentist chairs and electric wheelchairs. Its physical design is similar to the TA7, yet without the IP rating. The TA41 provides multiple options of cable exits and it supports a maximum of 800Kg force in push.

### General Features

Max. load	8,000N (push) : 4,000N (pull)
Max. speed at max. load	4.3mm/s
Max. speed at no load	39mm/s
Retracted length	≥ Stroke + 163mm
Stroke	25~1000mm
Output signals	Hall sensors, Reed sensor
Voltage	12/24/36V DC
Color	Black, grey
Operational temperature range	+5°C~+45°C
Suitable for dentist chairs and wheelchairs	

**Drawing**

Standard Dimensions  
(mm)

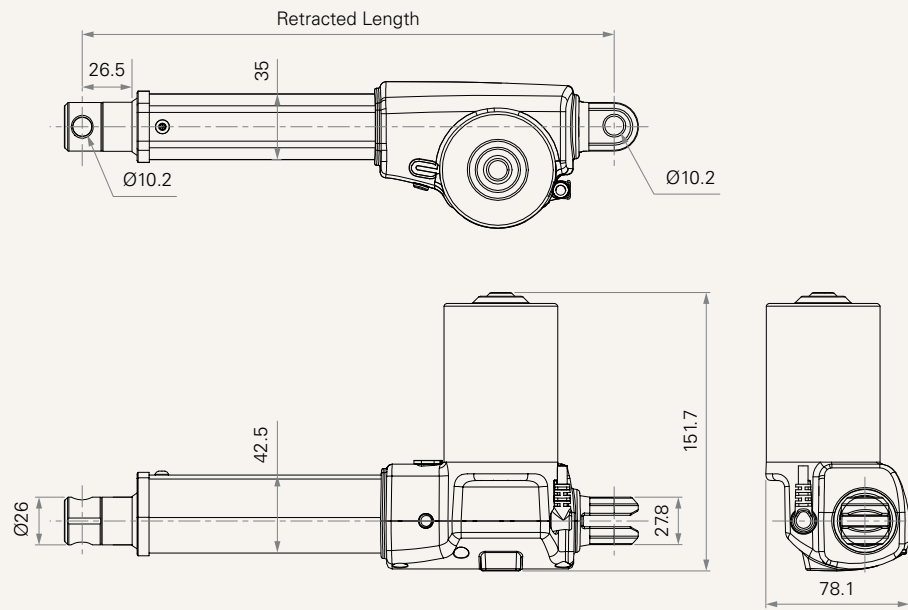

**Note**

- 1 The above dimension is with motor rubber cover.

## Load and Speed

CODE	Load (N)		Self Locking Force (N)	Typical Current (A)		Typical Speed (mm/s)	
	Push	Pull		No Load 32V DC	With Load 24V DC	No Load 32V DC	With Load 24V DC
<b>Motor Speed (2600RPM, Duty Cycle 10%)</b>							
<b>C</b>	5000	4000	5000	0.8	3.5	8.0	4.1
<b>D</b>	6000	4000	6000	0.8	3.5	6.0	3.1
<b>F</b>	2500	2500	2500	0.8	3.2	15.9	8.3
<b>G</b>	2000	2000	2000	0.8	2.8	21.4	12.1
<b>H</b>	1000	1000	1000	0.8	2.1	32.1	19.1
<b>J</b>	3500	3500	3500	0.8	3.6	11.9	6.0
<b>K</b>	8000	4000	8000	0.8	4.2	5.4	2.6
<b>Motor Speed (3400RPM, Duty Cycle 10%)</b>							
<b>L</b>	6000	4000	6000	1.0	4.2	7.3	4.1
<b>N</b>	2500	2500	2500	1.0	4.1	19.4	11.1
<b>O</b>	2000	2000	2000	1.0	4.0	26.1	14.9
<b>P</b>	1000	1000	1000	1.0	3.0	39.0	23.4
<b>Q</b>	3500	3500	3500	1.0	4.6	14.5	7.9
<b>R</b>	8000	4000	8000	1.0	5.2	6.6	3.4
<b>T</b>	5000	4000	5000	1.0	4.2	9.8	5.4
<b>Motor Speed (3800RPM, Duty Cycle 10%)</b>							
<b>Y</b>	8000	4000	8000	1.2	5.5	7.7	4.3
<b>U</b>	5000	4000	5000	1.2	4.7	11.3	6.6
<b>W</b>	2500	2500	2500	1.2	4.6	23.0	13.4
<b>Z</b>	3500	3500	3500	1.2	5.3	16.8	9.8

### Note

- Please refer to the approved drawing for the final authentic value.
- This self-locking force level is reached only when a short circuit is applied on the terminals of the motor. All the TiMOTION control boxes have this feature built-in.
- The current & speed in table are tested with 24V DC motor. With a 12V DC motor, the current is approximately twice the current measured in 24V DC. With a 36V DC motor, the current is approximately two-thirds the current measured in 24V DC. Speed will be similar for all the voltages.
- The current & speed in table are tested when the actuator is extending under push load.
- The current & speed in table and diagram are tested with TiMOTION control boxes, and there will be around 10% tolerance depending on different models of the control box. (Under no load condition, the voltage is around 32V DC. At rated load, the voltage output will be around 24V DC)
- Standard stroke: Min.  $\geq$  25mm, Max. please refer to below table.

CODE	Load (N)	Max Stroke (mm)
<b>K, R, Y</b>	$\geq$ 8000	450
<b>D, L</b>	$=$ 6000	600
<b>Others</b>	$<$ 6000	1000

**Performance Data (24V DC Motor)**

Motor Speed (2600RPM, Duty Cycle 10%)

Speed vs. Load

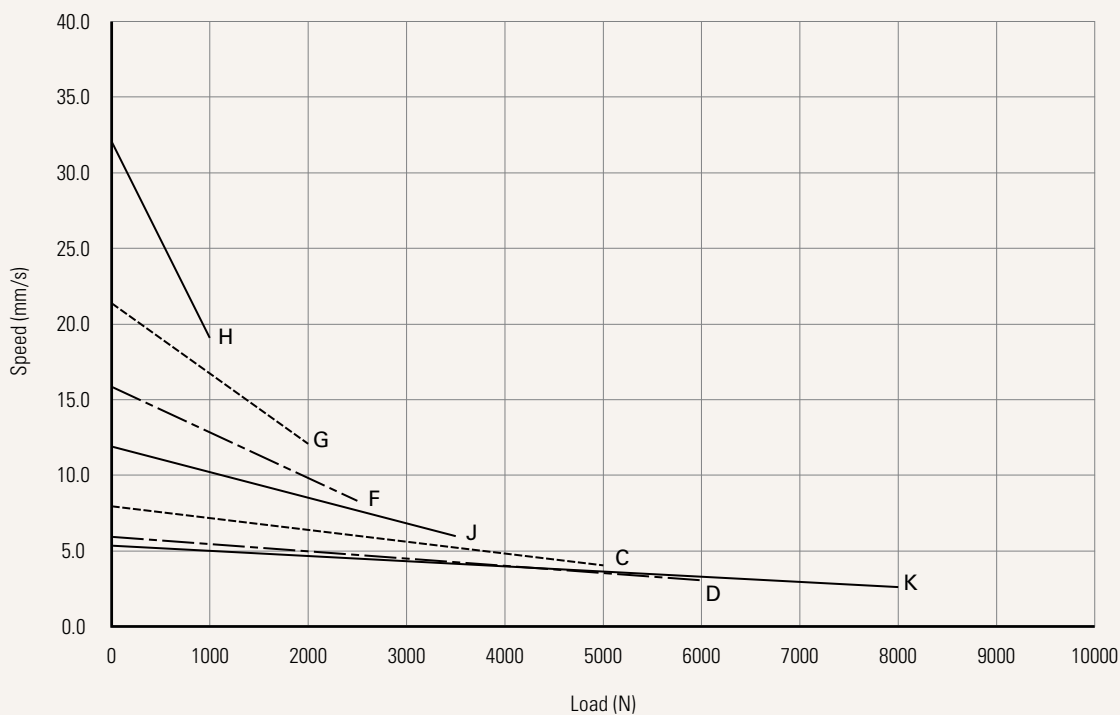

Current vs. Load

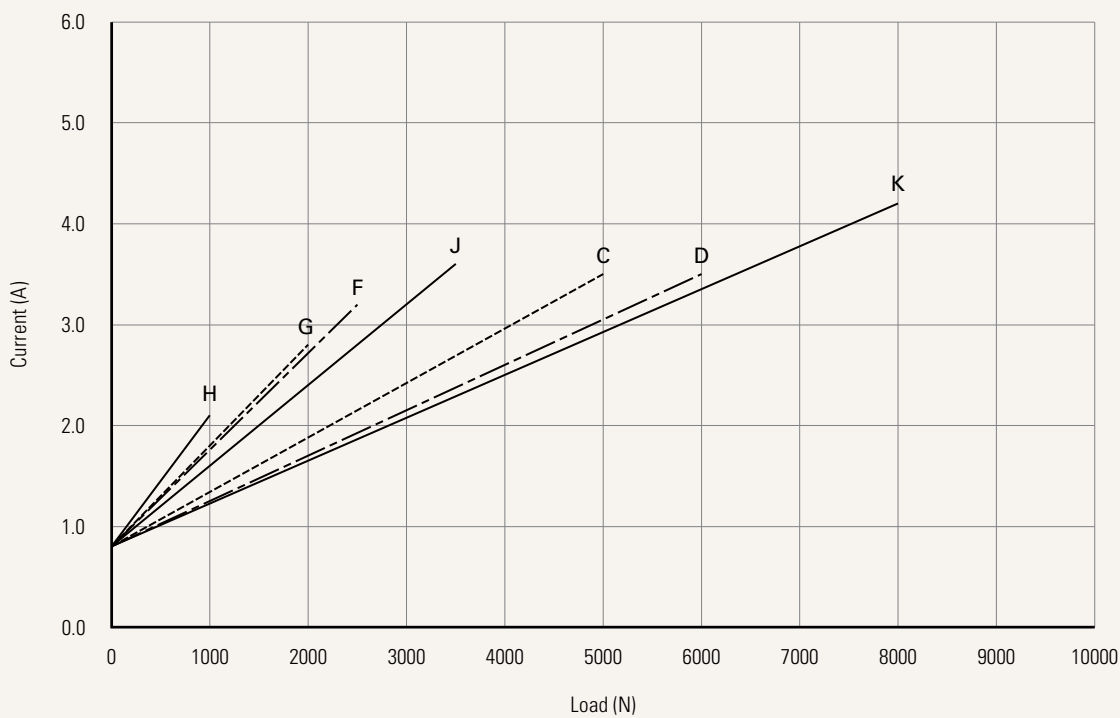

**Performance Data (24V DC Motor)**

Motor Speed (3400RPM, Duty Cycle 10%)

Speed vs. Load

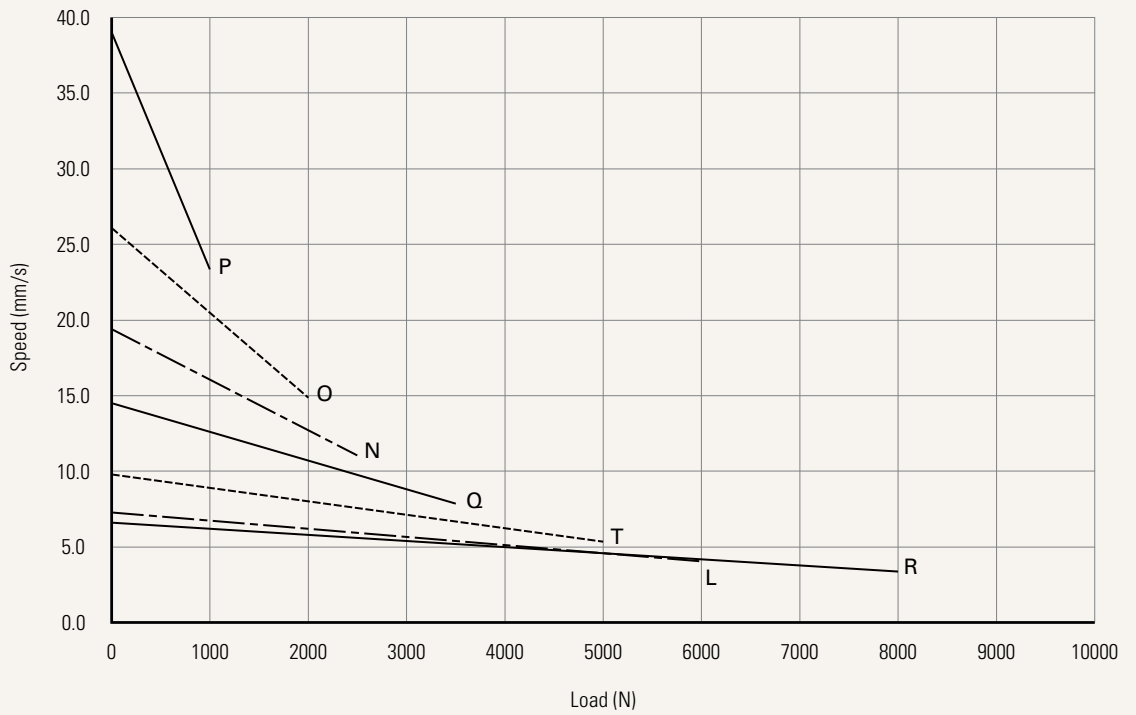

Current vs. Load

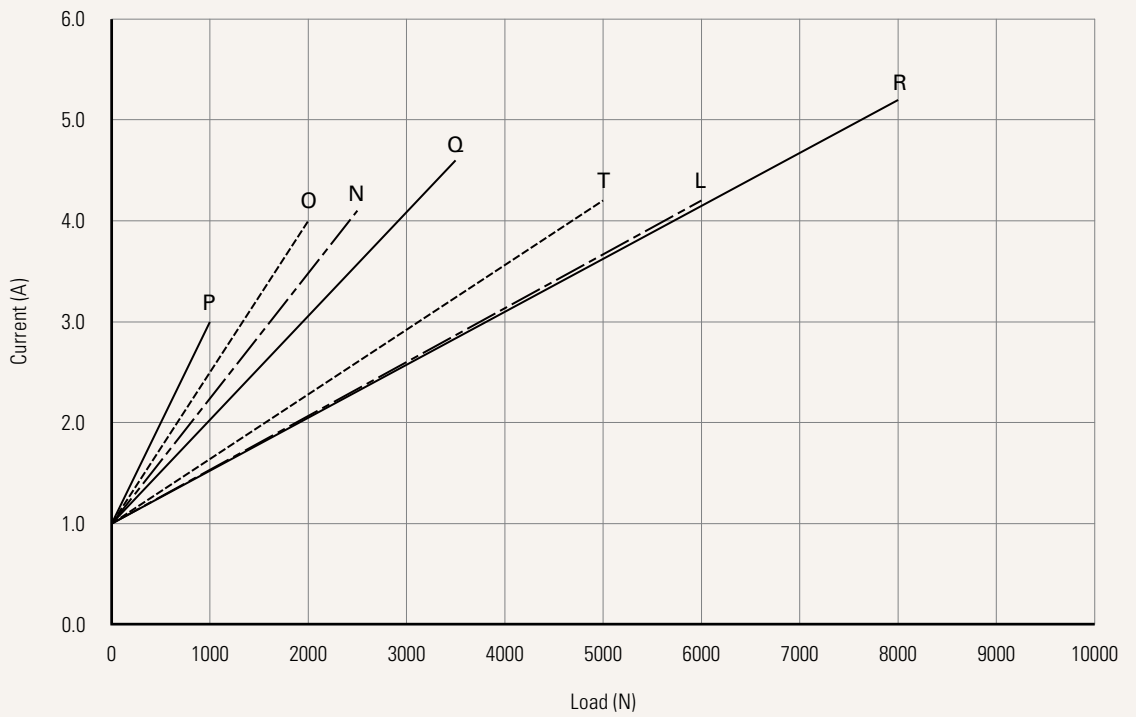

Performance Data (24V DC Motor)

Motor Speed (3800RPM, Duty Cycle 10%)

Speed vs. Load

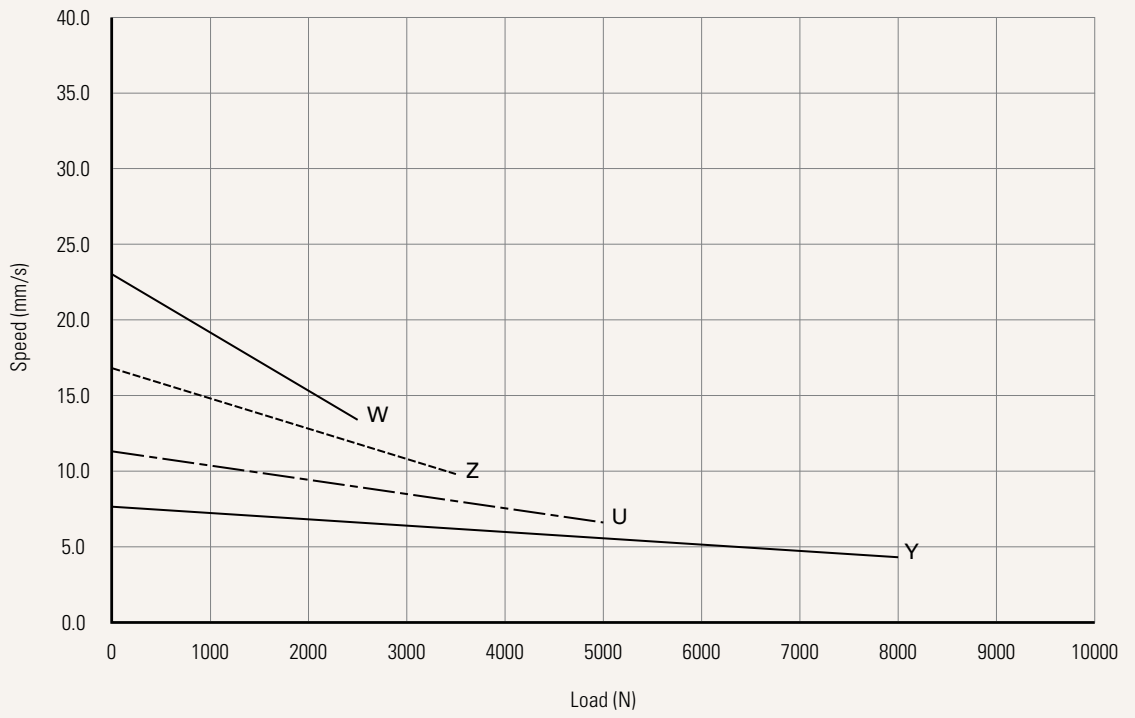

Current vs. Load

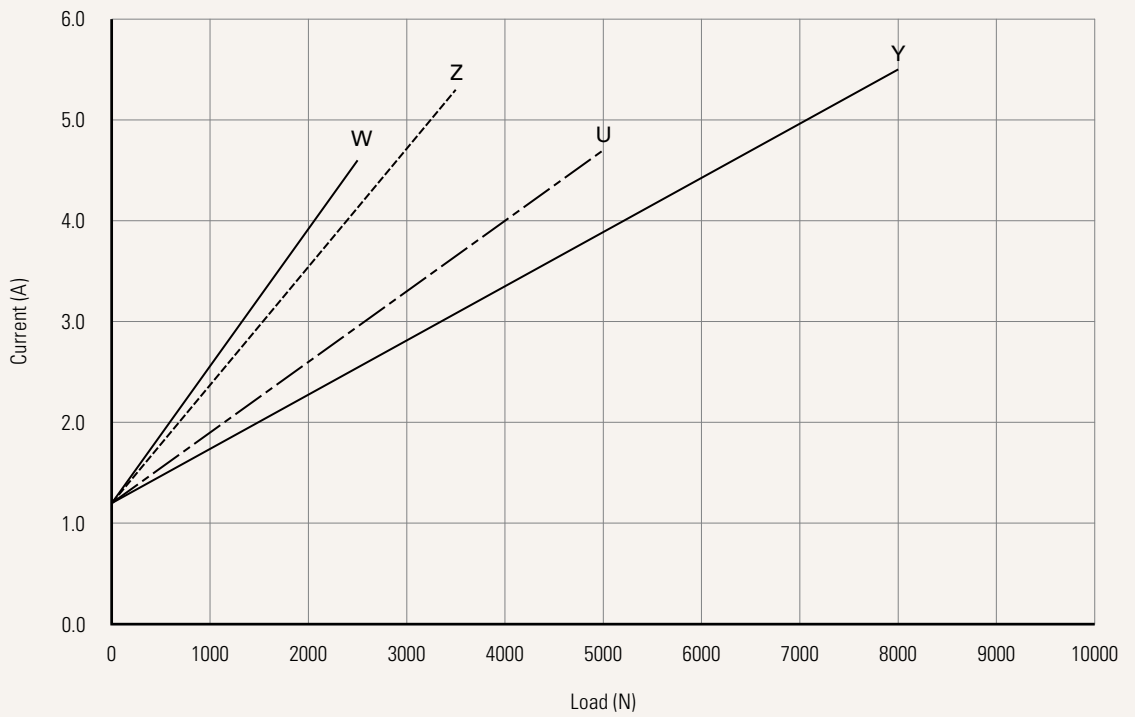

<b>Voltage</b>	1 = 12V DC	2 = 24V DC	3 = 36V DC
<b>Load and Speed</b>	<a href="#">See page 3</a>		
<b>Stroke (mm)</b>	<a href="#">See page 3</a>		
<b>Retracted Length (mm)</b>	<a href="#">See page 8</a>		
<b>Rear Attachment (mm)</b> <a href="#">See page 9</a>	2 = Aluminum casting, U clevis, slot 6.2, depth 17.0, hole 10.2 3 = Aluminum casting, U clevis, slot 6.2, depth 17.0, hole 12.2 4 = Aluminum casting, U clevis, slot 8.2, depth 17.0, hole 10.2 5 = Aluminum casting, U clevis, slot 8.2, depth 17.0, hole 12.2	C = Aluminum casting, U clevis, slot 8.2, depth 17.0, hole 10.2, T-bush F = Aluminum CNC, no slot, hole 10.2, T-bush	
<b>Front Attachment (mm)</b> <a href="#">See page 9</a>	0 = Without punched hole on inner tube, without slot, M22*2P inner threaded 1 = Punched hole on inner tube + plastic cap, without slot, hole 10.2, with plastic bushing 2 = Punched hole on inner tube + plastic cap, without slot, hole 12.2 3 = Plastic, U clevis, slot 8.2, depth 20.2, hole 10.2, for load push < 4000N & pull < 2500N 4 = Plastic, U clevis, slot 8.2, depth 20.2, hole 12.2, for load push < 4000N & pull < 2500N	5 = Punched hole on inner tube, without slot, hole 10.2, with plastic bushing 6 = Punched hole on inner tube, without slot, hole 12.2 7 = Aluminum casting, U clevis, slot 6.2, depth 17.0, hole 10.2 8 = Aluminum casting, U clevis, slot 6.2, depth 17.0, hole 12.2 9 = Aluminum casting, U clevis, slot 6.2, depth 17.0, hole 10.2, with plastic T-bushing J = Aluminum casting, without slot, hole 10.2, for dental chair	
<b>Direction of Rear Attachment (Counterclockwise)</b> <a href="#">See page 10</a>	1 = 0°	3 = 90°	
<b>Color</b>	1 = Black	2 = Pantone 428C	
<b>IP Rating</b>	1 = Without		
<b>Special Functions for Spindle Sub-Assembly</b>	0 = Without 1 = Safety nut	2 = Standard push only 3 = Standard push only + safety nut	
<b>Functions for Limit Switches</b> <a href="#">See page 10</a>	1 = Two switches at full retracted / extended positions to cut current 2 = Two switches at full retracted / extended positions to cut current + third one in between to send signal 3 = Two switches at full retracted / extended positions to send signal	4 = Two switches at full retracted / extended positions to send signal + third one in between to send signal 5 = Two switches at full retracted / extended positions to send signal	
<b>Output Signals</b>	0 = Without	2 = Hall sensor * 2	3 = Reed Sensor
<b>Connector</b> <a href="#">See page 11</a>	1 = DIN 6P, 90° plug 2 = Tinned leads 4 = Big 01P, plug C = Y cable (for direct cut system, no water proof, anti pull) E = Molex 8P, plug	F = DIN 6P, 180° plug M = DIN 4P, dental chair plug (40510-143, standard) N = DIN 4P, dental chair plug (40510-040) G = Audio plug P = Molex 8P, 90° plug, without anti-clip Q = Molex 6P, 90° plug	
<b>Cable Length (mm)</b>	0 = Straight, 100 1 = Straight, 500 2 = Straight, 750	3 = Straight, 1000 4 = Straight, 1250 5 = Straight, 1500	6 = Straight, 2000 7 = Curly, 200 8 = Curly, 400 B-H = For direct cut system, <a href="#">See page 11</a>
<b>The Position of Motor Connection</b>	1 = Top (close to front attachment)		2 = Bottom (close to rear attachment)

## Retracted Length (mm)

1. Calculate  $A+B+C = Y$
2. Retracted length needs to  $\geq \text{Stroke}+Y$

A.		
Front Attach.	Rear Attach.	
	F	2, 3, 4, 5, C
0	+163	+168
1, 2, 5, 6	-	+171
3, 4	-	+192
7, 8, 9	-	+183
J	-	+172

B.			
Stroke (mm)	Load (N)		
	< 6000	= 6000	= 8000
25~150	-	-	-
151~200	-	-	+5
201~250	-	+5	+10
251~300	-	+10	+15
301~350	+5	+15	+20
351~400	+10	+20	+25
401~450	+15	+25	+30
451~500	+20	+30	x
501~550	+25	+35	x
551~600	+30	+40	x
601~650	+35	x	x
651~700	+40	x	x
701~750	+45	x	x
751~800	+50	x	x
801~850	+55	x	x
851~900	+60	x	x
901~950	+65	x	x
951~1000	+70	x	x

C. Spindle Function		
N < 6000 (N)		
Front Attach.	0, 1	2, 3
0	-	-
1, 2, 5, 6	-	+5
3, 4	-	-
7, 8, 9	-	-
J	-	+5

C. Spindle Function		
N $\geq$ 6000 (N)		
Front Attach.	0, 1	2, 3
1, 2, 5, 6	-	+8
3, 4	-	-
7, 8, 9	-	+3
J	-	+8



## Rear Attachment (mm)

2 = Aluminum casting, U clevis, slot 6.2, depth 17.0, hole 10.2

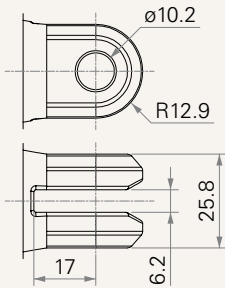

3 = Aluminum casting, U clevis, slot 6.2, depth 17.0, hole 12.2

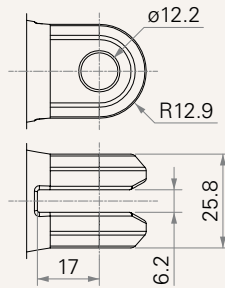

4 = Aluminum casting, U clevis, slot 8.2, depth 17.0, hole 10.2

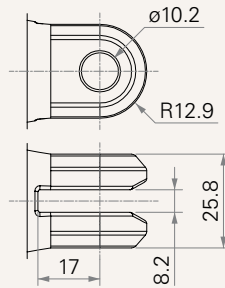

5 = Aluminum casting, U clevis, slot 8.2, depth 17.0, hole 12.2

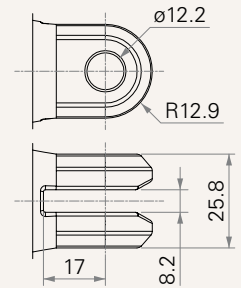

C = Aluminum casting, U clevis, slot 8.2, depth 17.0, hole 10.2, T-bush

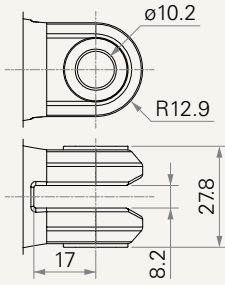

F = Aluminum CNC, no slot, hole 10.2, T-bush

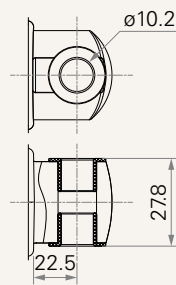

## Front Attachment (mm)

0 = Without punched hole on inner tube, without slot, M22\*2P inner threaded

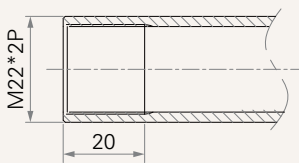

1 = Punched hole on inner tube + plastic cap, without slot, hole 10.2, with plastic bushing

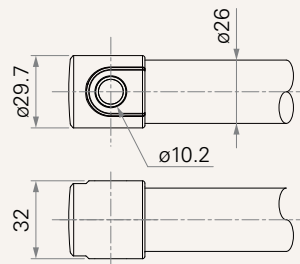

2 = Punched hole on inner tube + plastic cap, without slot, hole 12.2

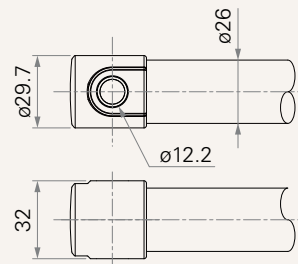

3 = Plastic, U clevis, slot 8.2, depth 20.2, hole 10.2, for load push < 4000N & pull < 2500N

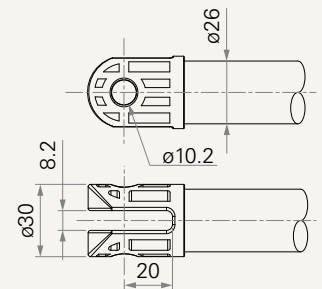

4 = Plastic, U clevis, slot 8.2, depth 20.2, hole 12.2, for load push < 4000N & pull < 2500N

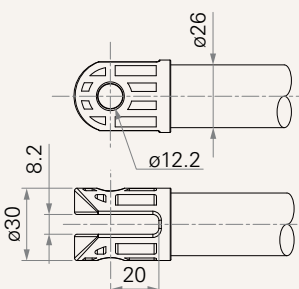

5 = Punched hole on inner tube, without slot, hole 10.2, with plastic bushing

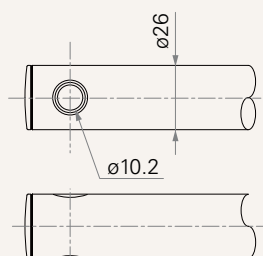

6 = Punched hole on inner tube, without slot, hole 12.2

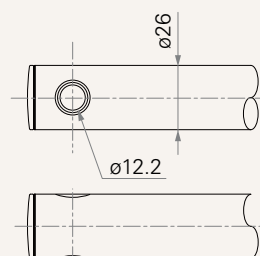

7 = Aluminum casting, U clevis, slot 6.2, depth 17.0, hole 10.2

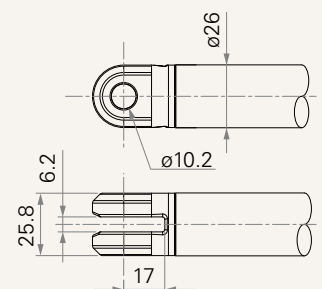

## Front Attachment (mm)

8 = Aluminum casting, U clevis, slot 6.2, depth 17.0, hole 12.2

9 = Aluminum casting, U clevis, slot 6.2, depth 17.0, hole 10.2, with plastic T-bushing

J = Aluminum casting, without slot, hole 10.2, for dental chair

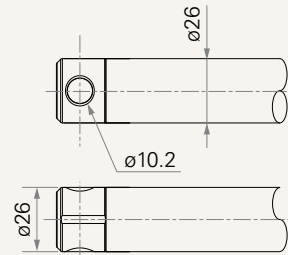
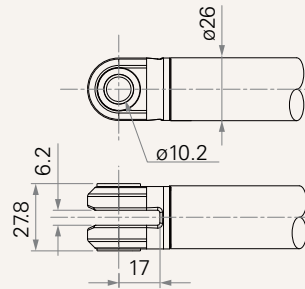
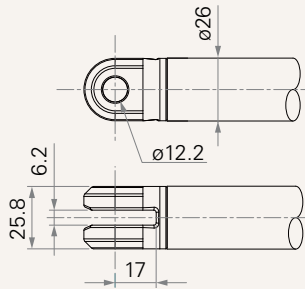

## Direction of Rear Attachment (Counterclockwise)

1 = 0°

3 = 90°

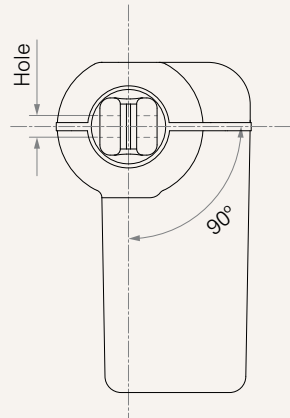
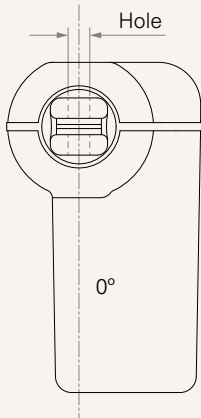

## Functions for Limit Switches

### Wire Definitions

CODE	Pin					
	● 1 (Green)	● 2 (Red)	○ 3 (White)	● 4 (Black)	● 5 (Yellow)	● 6 (Blue)
1	extend (VDC+)	N/A	N/A	N/A	retract (VDC+)	N/A
2	extend (VDC+)	N/A	middle switch pin B	middle switch pin A	retract (VDC+)	N/A
3	extend (VDC+)	common	upper limit switch	N/A	retract (VDC+)	lower limit switch
4	extend (VDC+)	common	upper limit switch	medium limit switch	retract (VDC+)	lower limit switch
5	extend (VDC+)	N/A	upper limit switch	common	retract (VDC+)	lower limit switch

## Connector

1 = DIN 6P, 90° plug

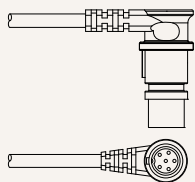

2 = Tinned leads



4 = Big 01P, plug

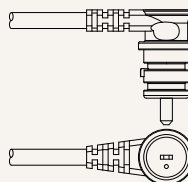

C = Y cable (for direct cut system, no water proof, anti pull)

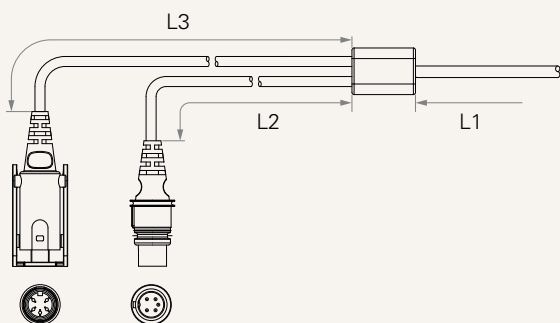

### Cable Length for Direct Cut System (mm)

CODE	L1	L2	L3
B	100	100	100
C	100	1000	400
D	100	2700	500
E	1000	100	100
F	100	600	1000
G	1500	1000	1000
H	100	100	1200

E = Molex 8P, plug

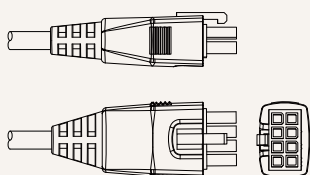

F = DIN 6P, 180° plug

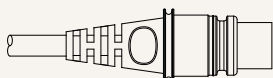

M = DIN 4P, dental chair plug (40510-143, standard)



N = DIN 4P, dental chair plug (40510-040)



G = Audio plug



P = Molex 8P, 90° plug, without anti-clip

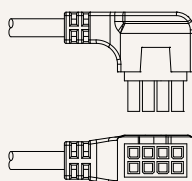

Q = Molex 6P, 90° plug

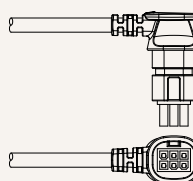

## Terms of Use

The user is responsible for determining the suitability of TiMOTION products for a specific application. TiMOTION products are subject to change without prior notice.