

TA37

series

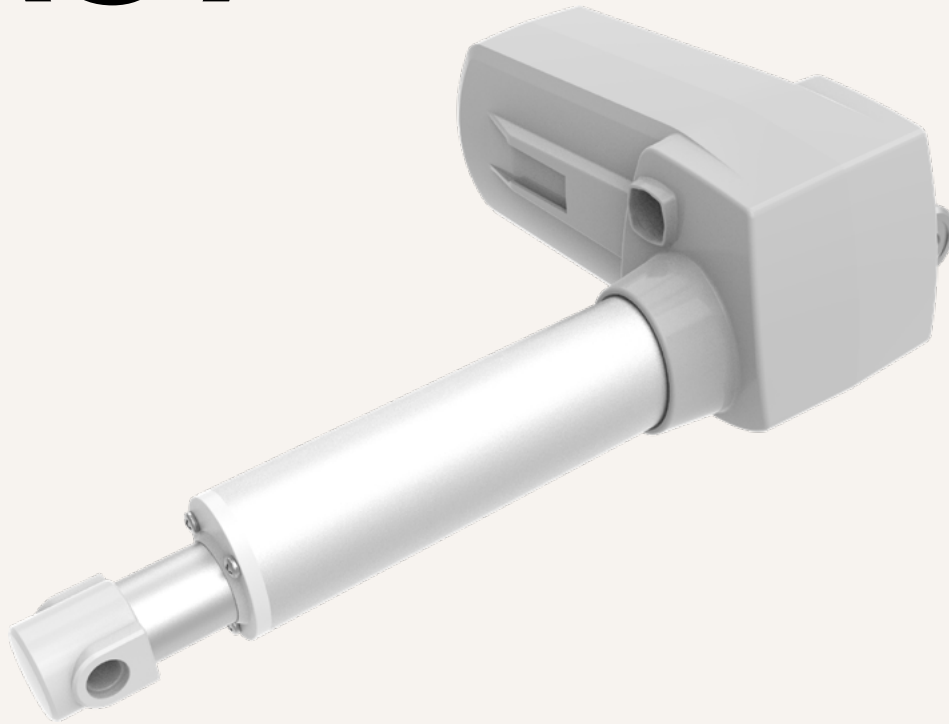

Product Segments

- **Care Motion**

TA37 is one of our high quality medical actuators. TA37 is recommended for the demanding force medical applications. It remains stable speed even under heavy loading. The maximum stroke of TA37 is up to 1000mm and its IP rating can support up to IP66W. The suitable medical applications for TA37 are treatment tables or patient hoist systems.

General Features

Max. load	12,000N (push)
Max. speed at max. load	5.3mm/s
Max. speed at no load	31.1mm/s
Retracted length	≥ Stroke + 170mm
IP rating	IP66W
Certificate	IEC60601-1
Stroke	25~1000mm
Output signals	Hall sensors
Options	Manual release (for patient hoist)
Voltage	24 / 36V DC (thermal protector)
Color	Black or grey
Operational temperature range	+5°C~+45°C
Suitable for patient hoist application	

Drawing

Standard Dimensions
(mm)

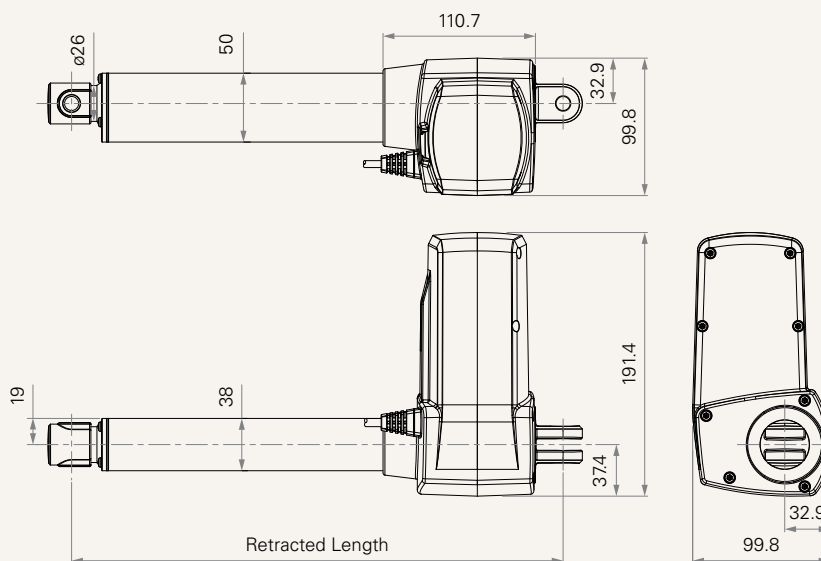

Load and Speed

CODE	Load (N)	Self Locking Force (N)	Typical Current (A)		Typical Speed (mm/s)	
	Push		No Load 32V DC	With Load 24V DC	No Load 32V DC	With Load 24V DC
Motor Speed (4100RPM, duty cycle 10%)						
B	4000	4000	2.0	8.0	31.1	18.0
C	6000	6000	2.0	10.0	23.1	13.3
D	8000	8000	2.0	8.4	13.3	8.3
E	10000	10000	2.0	9.2	11.5	7.0
F	12000	12000	2.0	9.2	8.7	5.3

Note

- 1 Please refer to the approved drawing for the final authentic value.
- 2 Max static pull load 4,000N, dynamic pull not allowed.
- 3 This self-locking force level is reached only when a short circuit is applied on the terminals of the motor. All the TiMOTION control boxes have this feature built-in.
- 4 The current & speed in table are tested with 24V DC motor. With a 12V DC motor, the current is approximately twice the current measured in 24V DC. With a 36V DC motor, the current is approximately two-thirds the current measured in 24V DC. Speed will be similar for all the voltages.
- 5 The current & speed in table are tested when the actuator is extending under push load.
- 6 The current & speed in table and diagram are tested with TiMOTION control boxes, and there will be around 10% tolerance depending on different models of the control box. (Under no load condition, the voltage is around 32V DC. At rated load, the voltage output will be around 24V DC)
- 7 Standard stroke: Min. ≥ 25 mm, Max. please refer to below table.

CODE	Load (N)	Max Stroke (mm)
B	4000	1000
C	6000	900
D	8000	800
E	10000	650
F	12000	450

Performance Data (24V DC)

Motor Speed (4100RPM, duty cycle 10%)

Speed vs. Load

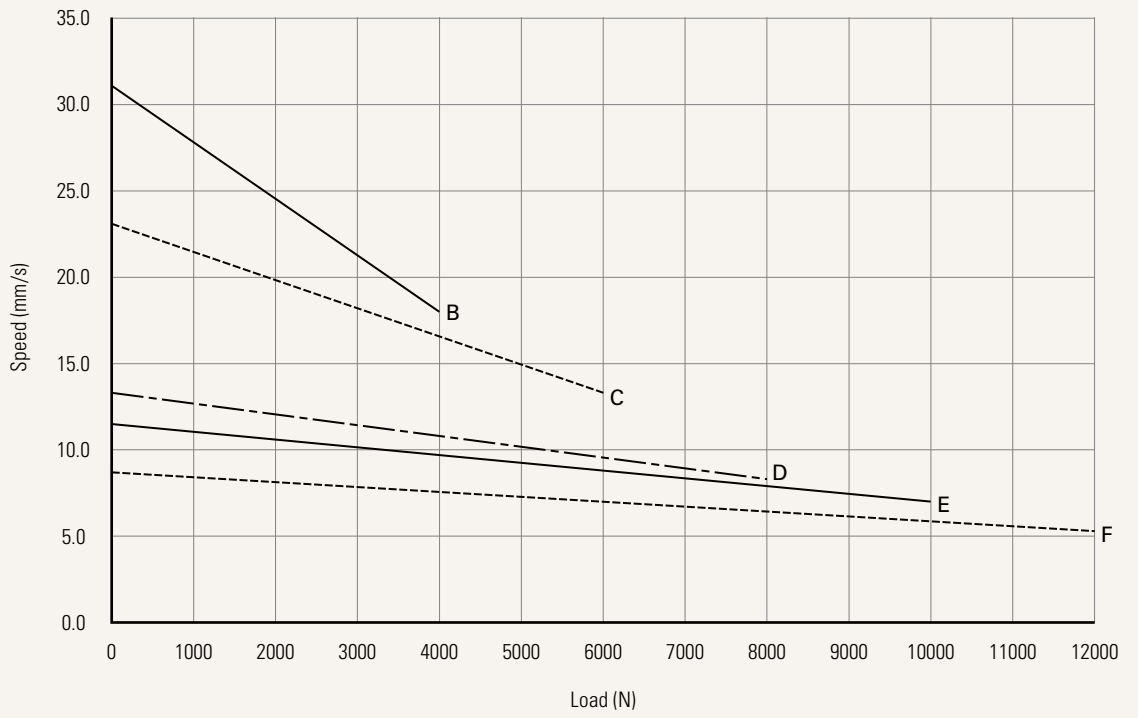

Current vs. Load

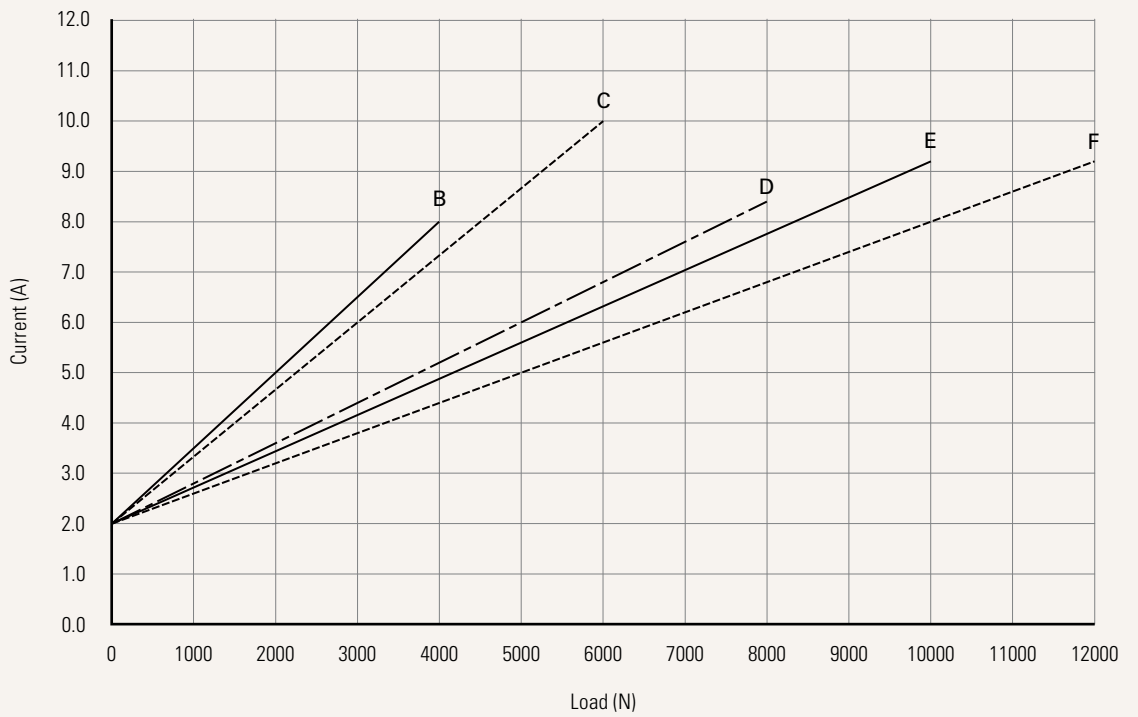

Voltage	5 = 24V DC, thermal protector	7 = 36V DC, thermal protector		
Load and Speed	See page 2			
Stroke (mm)	See page 2			
Retracted Length (mm)	See page 6			
Rear Attachment (mm)	1 = Aluminum casting, U clevis, slot 6.2, depth 19.5, hole 10.2	4 = Aluminum casting, U clevis, slot 8.2, depth 19.5, hole 12.2		
See page 6	2 = Aluminum casting, U clevis, slot 6.2, depth 19.5, hole 12.2	C = Aluminum casting, U clevis, slot 8.2, depth 19.5, hole 10.2, with plastic T-bushing		
	3 = Aluminum casting, U clevis, slot 8.2, depth 19.5, hole 10.2			
Front Attachment (mm)	1 = Punched hole on inner tube + plastic cap, without slot, hole 10.2, with plastic bush	9 = Aluminum casting, U clevis, slot 6.2, depth 17.0, hole 10.2, with plastic T-bushing		
See page 7	2 = Punched hole on inner tube + plastic cap, without slot, hole 12.2	K = Aluminum casting, U clevis, slot 8.2, depth 17.0, hole 10.2		
	7 = Aluminum casting, U clevis, slot 6.2, depth 17.0, hole 10.2	L = Aluminum casting, U clevis, slot 8.2, depth 17.0, hole 12.2		
	8 = Aluminum casting, U clevis, slot 6.2, depth 17.0, hole 12.2	M = Aluminum casting, U clevis, slot 8.2, depth 17.0, hole 10.2, with plastic T-bushing		
Direction of Rear Attachment (Counterclockwise)	1 = 0°	3 = 90°		
See page 7				
Color	1 = Black	2 = Pantone 428C		
IP Rating	1 = Without	2 = IP54	3 = IP66	5 = IP66W
Special Functions for Spindle Sub-Assembly	0 = Without (standard)	2 = Standard push only		
	1 = Safety nut	3 = Standard push only + safety nut		
Functions for Limit Switches	1 = Two switches at full retracted / extended positions to cut current			
See page 8	2 = Two switches at full retracted / extended positions to cut current + third one in between to send signal			
	3 = Two switches at full retracted / extended positions to send signal			
	4 = Two switches at full retracted / extended positions to send signal + third one in between to send signal			
	5 = Two switches at full retracted / extended positions to send signal (For TC1, TC8, TC10, TC14, TC21)			
Output Signals	0 = Without	2 = Hall sensor*2		
Connector	1 = DIN 6P, 90° plug	E = Molex 8P, plug	P = Molex 8P, 90° plug, without anti-clip	R = Molex 6P, 180°plug
See page 8	2 = Tinned leads	F = DIN 6P, 180° plug	Q = Molex 6P, 90°plug	
	4 = Big 01P, plug	G = Audio plug		
Cable Length (mm)	0 = Straight, 100	3 = Straight, 1000	6 = Straight, 2000	8 = Curly, 400
	1 = Straight, 500	5 = Straight, 1500	7 = Curly, 200	

TA37 Patient Hoist Ordering Key

TA37

Version: 20241212-P

Voltage	5 = 24V DC, thermal protector	7 = 36V DC, thermal protector		
Load and Speed	E = 10000N	F = 12000N		
Stroke (mm)	See page 2			
Retracted Length (mm)	See page 6			
Rear Attachment (mm)	C = Aluminum casting, U clevis, slot 8.2, depth 19.5, hole 10.2, with plastic T-bushing			
	See page 6			
Front Attachment (mm)	F = Aluminum casting, U clevis, slot 8.2, depth 19.0, hole 10.2, with plastic T-bushing, for Manual Release			
	I = Aluminum casting, U clevis, slot 8.2, depth 39.0, hole 10.2, with plastic T-bushing, for manual release			
	G = Aluminum casting, U clevis, slot 8.2, depth 19.0, hole 10.2, with plastic T-bushing, Without press down for manual release			
Direction of Rear Attachment (Counterclockwise)	1 = 0°			
	See page 7			
Color	1 = Black	2 = Pantone 428C		
IP Rating	1 = Without	2 = IP54	3 = IP66	5 = IP66W
Emergency Release Function	5 = Manual release			
Special Functions for Spindle Sub-Assembly	6 = Mechanical push only + safety nut			
Functions for Limit Switches	1 = Two switches at full retracted / extended positions to cut current			
	See page 8			
Output Signals	0 = Without			
Connector	1 = DIN 6P, 90° plug	G = Audio plug	R = Molex 6P, 180°plug	
	F = DIN 6P, 180° plug	Q = Molex 6P, 90°plug		
Cable Length (mm)	1 = Straight, 500	3 = Straight, 1000	5 = Straight, 1500	6 = Straight, 2000

Retracted Length (mm)

1. Calculate A+B = Y
2. Retracted length needs to \geq Stroke + Y

A.		
Front Attach.	General	For Patient Hoist
1, 2	170	-
7, 8, 9, K, L, M	178	-
F, G (Patient hoist)	-	267
I (Patient hoist)	-	287

Stroke (mm)	B.					
	Load (N)					Patient Hoist
	General					
	= 4000	= 6000	= 8000	= 10000	= 12000	
25~150	-	-	-	+5	+10	-
151~200	-	-	+5	+10	+15	-
201~250	-	+5	+10	+15	+20	-
251~300	+5	+10	+15	+20	+25	+5
301~350	+10	+15	+20	+25	+30	+10
351~400	+15	+20	+25	+30	+35	+15
401~450	+20	+25	+30	+35	+40	+20
451~500	+25	+30	+35	+40	+45	+25
501~550	+30	+35	+40	+45	+50	+30
551~600	+35	+40	+45	+50	+55	+35
601~650	+40	+45	+50	+55	+60	+40
651~700	+45	+50	+55	+60	+65	+45
701~750	+50	+55	+60	+65	+70	+50
751~800	+55	+60	+65	+70	+75	+55
801~850	+60	+65	+70	+75	+80	+60
851~900	+65	+70	+75	+80	+85	+65
901~950	+70	+75	+80	+85	+90	+70
951~1000	+75	+80	+85	+90	+95	+75

Rear Attachment (mm)

1 = Aluminum casting, U clevis, slot 6.2, depth 19.5, hole 10.2

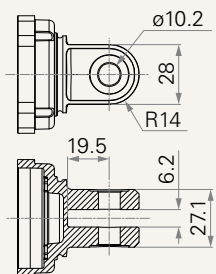

2 = Aluminum casting, U clevis, slot 6.2, depth 19.5, hole 12.2

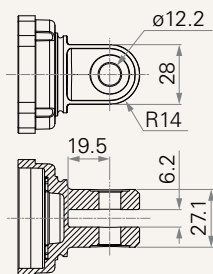

3 = Aluminum casting, U clevis, slot 8.2, depth 19.5, hole 10.2

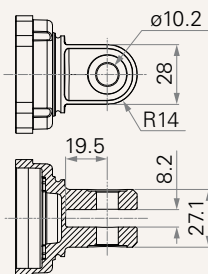

4 = Aluminum casting, U clevis, slot 8.2, depth 19.5, hole 12.2

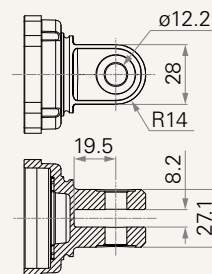

C = Aluminum casting, U clevis, slot 8.2, depth 19.5, hole 10.2, with plastic T-busing

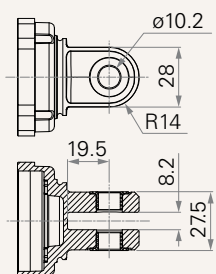

Front Attachment (mm)

1 = Punched hole on inner tube + plastic cap, without slot, hole 10.2, with plastic bush

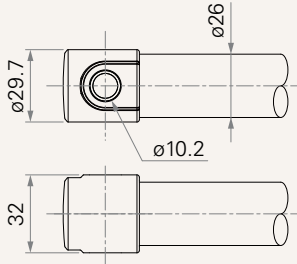

2 = Punched hole on inner tube + plastic cap, without slot, hole 12.2

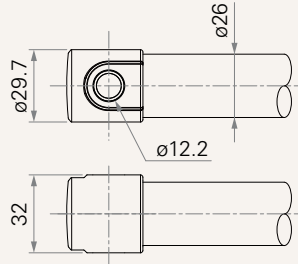

7 = Aluminum casting, U clevis, slot 6.2, depth 17.0, hole 10.2

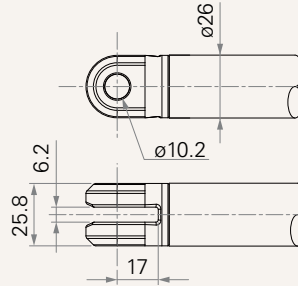

8 = Aluminum casting, U clevis, slot 6.2, depth 17.0, hole 12.2

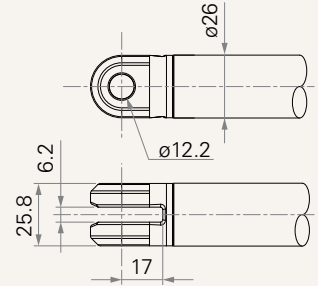

9 = Aluminum casting, U clevis, slot 6.2, depth 17.0, hole 10.2, with plastic T-bushing

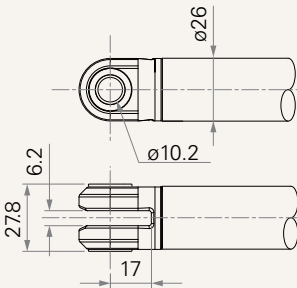

F = Aluminum casting, U clevis, slot 8.2, depth 19.0, hole 10.2, with plastic T-bushing, for Manual Release

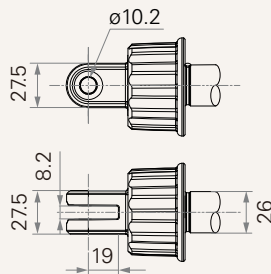

G = Aluminum casting, U clevis, slot 8.2, depth 19.0, hole 10.2, with plastic T-bushing, Without press down for manual release

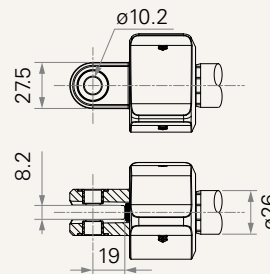

I = Aluminum casting, U clevis, slot 8.2, depth 39.0, hole 10.2, with plastic T-bushing, for manual release

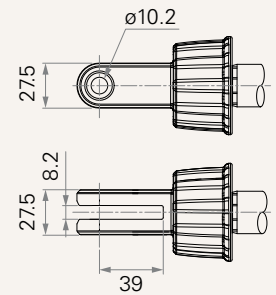

K = Aluminum casting, U clevis, slot 8.2, depth 17.0, hole 10.2

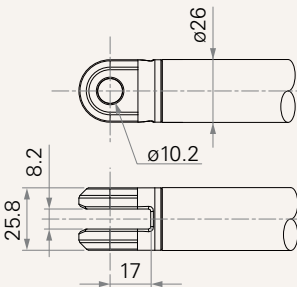

L = Aluminum casting, U clevis, slot 8.2, depth 17.0, hole 12.2

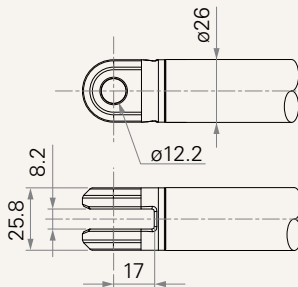

M = Aluminum casting, U clevis, slot 8.2, depth 17.0, hole 10.2, with plastic T-bushing

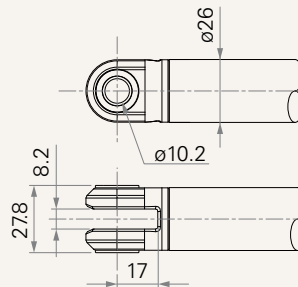

Direction of Rear Attachment (Counterclockwise)

1 = 0°

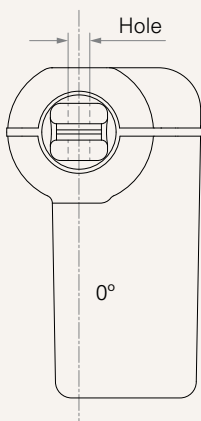

3 = 90°

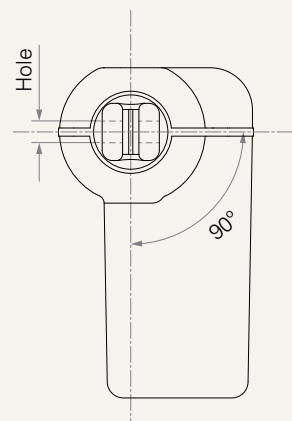

Functions for Limit Switches

Wire Definitions

CODE	Pin					
	● 1 (Green)	● 2 (Red)	○ 3 (White)	● 4 (Black)	● 5 (Yellow)	● 6 (Blue)
1	extend (VDC+)	N/A	N/A	N/A	retract (VDC+)	N/A
2	extend (VDC+)	N/A	middle switch pin B	middle switch pin A	retract (VDC+)	N/A
3	extend (VDC+)	common	upper limit switch	N/A	retract (VDC+)	lower limit switch
4	extend (VDC+)	common	upper limit switch	medium limit switch	retract (VDC+)	lower limit switch
5	extend (VDC+)	N/A	upper limit switch	common	retract (VDC+)	lower limit switch

Connector

1 = DIN 6P, 90° plug

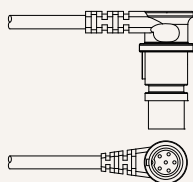

2 = Tinned leads



4 = Big 01P, plug

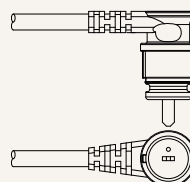

E = Molex 8P, plug

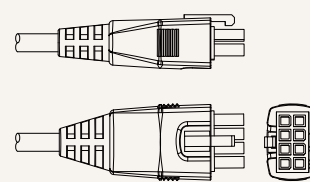

F = DIN 6P, 180° plug

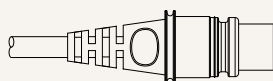

G = Audio plug



P = Molex 8P, 90° plug, without anti-clip

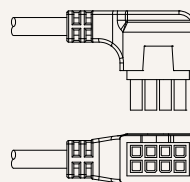

Q = Molex 6P, 90° plug

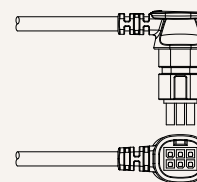

R = Molex 6P, 180° plug

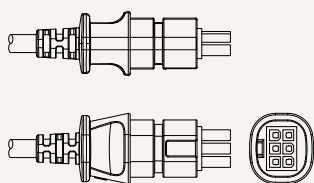

Terms of Use

The user is responsible for determining the suitability of TiMOTION products for a specific application. TiMOTION products are subject to change without prior notice.