

BP-TEKaiir series

Lightweight Dual Motor Desk Frame

General Features

Max. load	100kg (per frame)
Constant speed	2-Stage Column: 30mm/s; 3-Stage Column: 33mm/s
Weight of package	Box 1 (Frame 1): 23kg Box 2 (Frame 2): 23kg Box 3 (side beams): 8kg
Standby power	< 0.1W
Accessories	USB Chargers (TFA1/TFA3/TFA6), Anti-Collision Sensor (TCS1), Wireless Chargers (TWC)
Unique lightweight frame design	
Light in weight, solid in structure	
Pre-assembled frame kit – Quick and effortless assembly	



Color (RAL Classic)

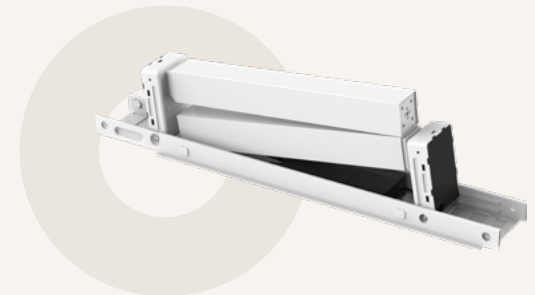

*For more color options, please consult your sales representative.

Dimension

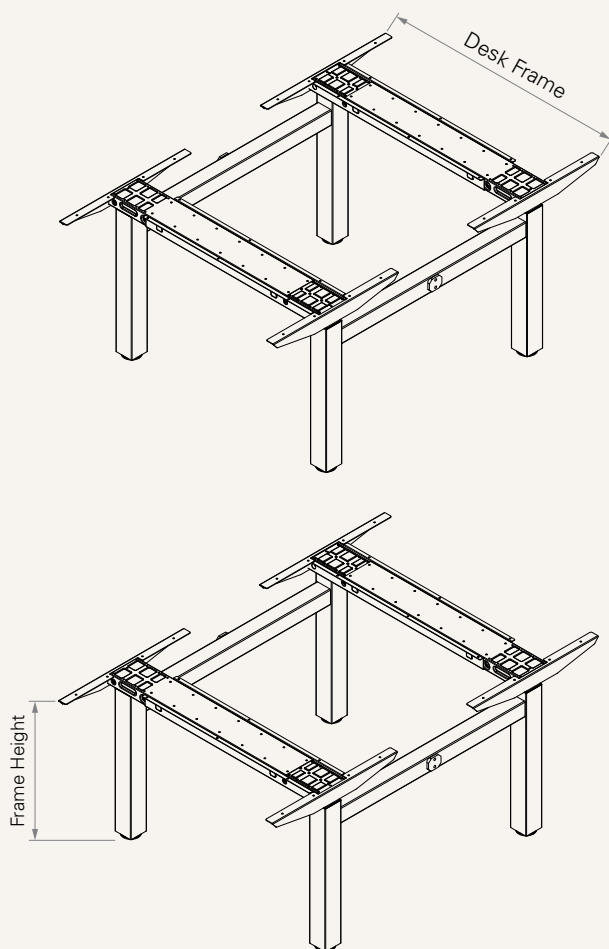

Frame & Work Surface

Frame Type	Frame dimensions (mm)	Recommended work surface dimensions (mm)	
	Width (mm)	Width (mm)	Depth (mm)
Normal	946~1546	1000~1600	600~800
Extended	1040~1740	1100~1800	600~800

Hight Range

Column type	Frame height (mm)	Stroke (mm)
3-Stage	630~1280	650
3-Stage (M)	600~1260	660
3-Stage (S)	560~1220	660
2-Stage	680~1180	500

Side Beam

1 = One side bracket welded

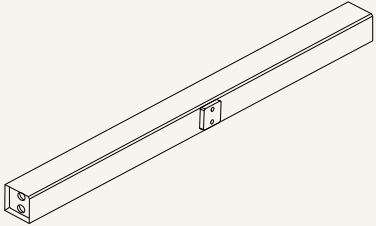

TL Model

• 3-Stage

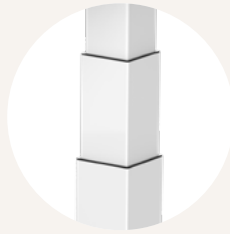
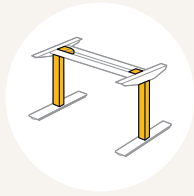

TEL01-MS
Square
70 x 70 mm



TEL03-MS
Round
ø70 mm

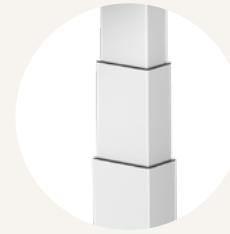

TEL05-MS
Rectangular
83 x 53 mm



TEL07-MS
Rectangular
80 x 50 mm

• 2-Stage



TEL02-MS
Square
70 x 70 mm



TEL04-MS
Round
ø70 mm



TEL06-MS
Rectangular
83 x 53 mm



TEL10-MS
Rectangular
75 x 45 mm

End Pipe



Style A
(for fixed tabletop)

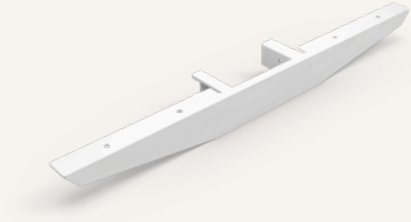

Hand Control



01 = TDH1



02 = TDH2



03 = TDH3



04 = TDH4



05 = TDH5



06 = TDH6



07 = TDH8



08 = TDH8D



09 = TDH9P



10 = TDH8P



11 = TDH11P



12 = TDH12P



13 = TDH13P



15 = TDH15



16 = TDH16



17 = TDH17



18 = TDH18P



19 = TDH6PR



20 = TDH20P



21 = TH37



22 = TFH8

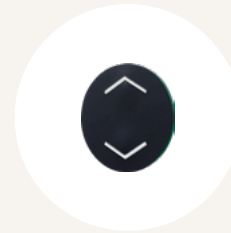

23 = TFH13



24 = TDH24P



25 = TDH5PR

Hand Control



26 = TDH5C



27 = TDH27P



28 = TDH18C



29 = TDH29



30 = TFH21



31 = TFH22



34 = TH14

Accessories (optional)



TCS1

TCS1 is a collision sensor based on t-touch technology which does not require any additional hardware upgrades.



TFA1

A charger with 2 USB ports. Can be mounted on the table top.



TFA3

A charger with 2 USB ports. Can be mounted to the desk front side.



TWC

Designed for wireless charging of mobile devices. Can be mounted on the table top.

BP-TEKaiir Ordering Key

BP-TEKaiir

Version: 20241007-D

TL Model	01MS = TEL01-MS	02MS = TEL02-MS	03MS = TEL03-MS	04MS = TEL04-MS	05MS = TEL05-MS	06MS = TEL06-MS	07MS = TEL07-MS	10MS = TEL10-MS
See page 4								
TC Model	0 = Without		1 = TC15S (Quick Release version)					
Hand Control	See page 6-7							
Color	1 = Black (RAL 9005)		2 = White (RAL 9016)		3 = Grey (RAL 9006)		4 = Special grey (RAL 9022)	
Foot	0 = Big shoe (requires column with extended outer tube), standard				3 = Small shoe (requires column with extended outer tube), for rectangular column			
	2 = Foot cap + Big shoe							
End Pipe (mm)	1 = Style A, fixation holes, fixed with desk frame, E1 & E2: 550 (TEKaiir only)							
See page 5								
Desk Frame (mm)	1 = Normal, W: 946-1546			2 = Extended, W: 1040-1740				
Side Beam	See page 3							
Middle Beam	0 = Without							
Assembly Manual	0 = Without		E = English, TiMOTION logo, Black/White printing		2 = English, TiMOTION logo, colour printing		5 = Chinese, No logo, colour printing	
	C = Chinese, TiMOTION logo, Black/White printing		1 = Chinese, TiMOTION logo, colour printing		3 = Chinese, No logo, Black/White printing		6 = English, No logo, colour printing	
					4 = English, No logo, Black/White printing			

Terms of Use

The user is responsible for determining the suitability of TiMOTION products for a specific application. TiMOTION products are subject to change without prior notice.