

# TEK37 series

## Single Column Desk Frame

### General Features

Max. load	60kg
Speed	40mm/s
Weight of package	19kg
Standby power	< 0.1W
Accessories (optional)	USB Chargers (TFA1/TFA3), Anti-Collision Sensor (TCS1), Wireless Chargers (TWC)

Optional castor and battery available

Remote control and Bluetooth receiver available

Compact and lightweight packaging



### Color (RAL Classic)

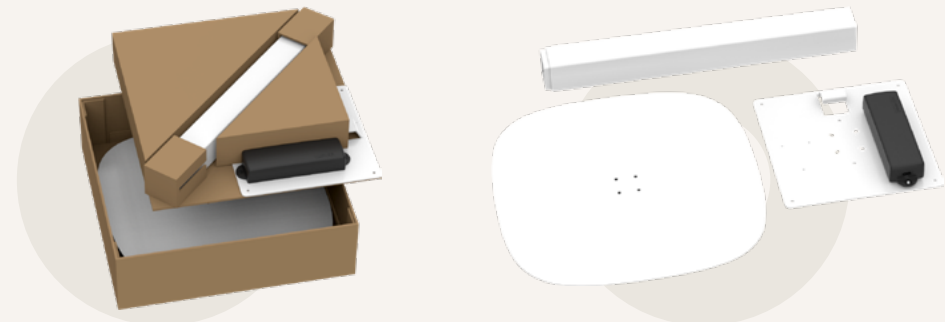

\*For more color options, please consult your sales representative.

**Dimension**

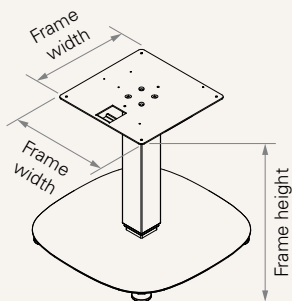

• 3-Stage

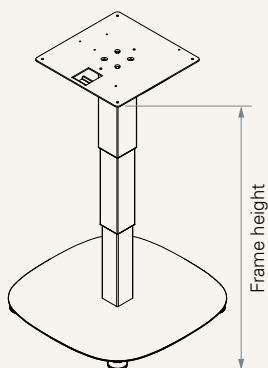

• 2-Stage

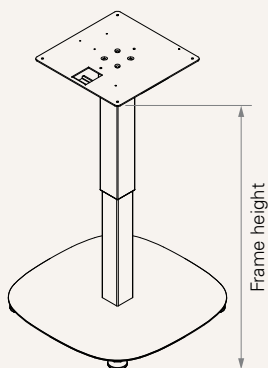

**Frame & Work Surface**

Frame dimensions (mm)	Recommended work surface dimensions (mm)	
Length*Width (mm)	Length (mm)	Width (mm)
300*300	400~650	400~650

**Height Range**

Column type	Frame height (mm)	Stroke (mm)
3-stage (coffee table)	455~745	290
2-Stage (side table)	650~1050	400



Desk Type



Freestanding



Foot



Style A

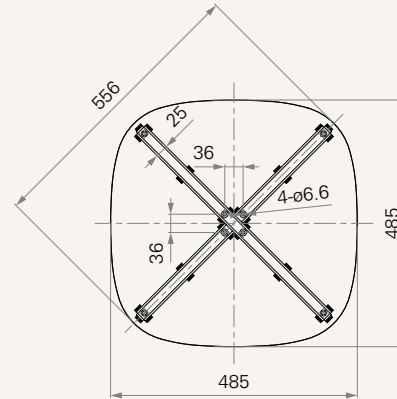

**TL Model**

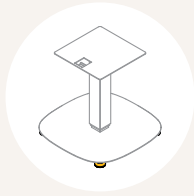

1 = Shoe, standard

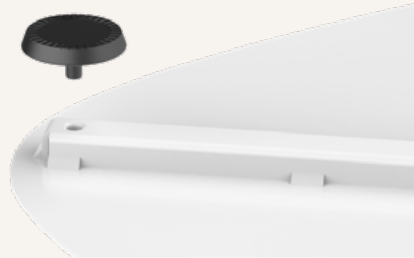

2 = Movable casters



3 = Shoe + movable casters



Hand Control



1 = TDH1



2 = TDH2



3 = TDH3



4 = TDH4



5 = TDH5



6 = TDH6



7 = TDH8



8 = TDH8D



9 = TDH9P



10 = TDH8P



11 = TDH11P



12 = TDH12P



13 = TDH13P



15 = TDH15



16 = TDH16



17 = TDH17



18 = TDH18P



19 = TDH6PR



20 = TDH20P



21 = TH37



22 = TFH8

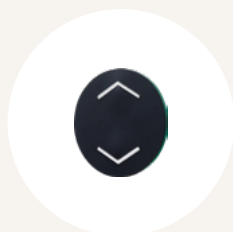

23 = TFH13



24 = TDH24P



25 = TDH5PR

**Hand Control**



26 = TDH5C



27 = TDH27P



28 = TDH18C



29 = TDH29



30 = TFH21



31 = TFH22



34 = TH14

**Accessories (optional)**



TCS1

TCS1 is a collision sensor based on t-touch technology which does not require any additional hardware upgrades.



TFA1

A charger with 2 USB ports. Can be mounted on the table top.



TFA3

A charger with 2 USB ports. Can be mounted to the desk front side.



TWC

Designed for wireless charging of mobile devices. Can be mounted on the table top.

# TEK37 Ordering Key

TEK37

Version: 20240423-C

<b>TL Model</b> <a href="#">See page 3</a>	20SR = TL20SR	38SR = TL38SR		
<b>Top Plate (mm)</b> <a href="#">See page 3</a>	1 = Style A, thickness 3, Standard			
<b>Foot (mm)</b> <a href="#">See page 4</a>	0 = Without	1 = Style A, thickness: 3, Standard		
<b>Accessories for Foot</b> <a href="#">See page 5</a>	1 = Shoe (pre-assambled), standard	2 = Movable casters (inner box package with wrench)		3 = Shoe + movable casters
<b>Desk Type</b> <a href="#">See page 4</a>	0 = Freestanding			
<b>Color</b>	1 = Black, RAL 9005	2 = White, RAL 9016	3 = Grey, RAL 9006	4 = Special grey, RAL 9022
<b>TC</b>	0 = Without	1 = TC11	2 = TC11P	
<b>Hand Control</b>	<a href="#">See page 6-7</a>			
<b>Charger Model</b>	0 = Without			
<b>Assembly Manual</b>	0 = Without	3 = Chinese, No logo, Black/White printing		4 = English, No logo, Black/White printing
	C = Chinese, TiMOTION logo, Black/White printing	4 = English, No logo, Black/White printing		5 = Chinese, No logo, colour printing
	E = English, TiMOTION logo, Black/White printing	5 = Chinese, No logo, colour printing		6 = English, No logo, colour printing
	1 = Chinese, TiMOTION logo, colour printing	6 = English, No logo, colour printing		
	2 = English, TiMOTION logo, colour printing			

## Terms of Use

The user is responsible for determining the suitability of TiMOTION products for a specific application. TiMOTION products are subject to change without prior notice.