

TA43

series

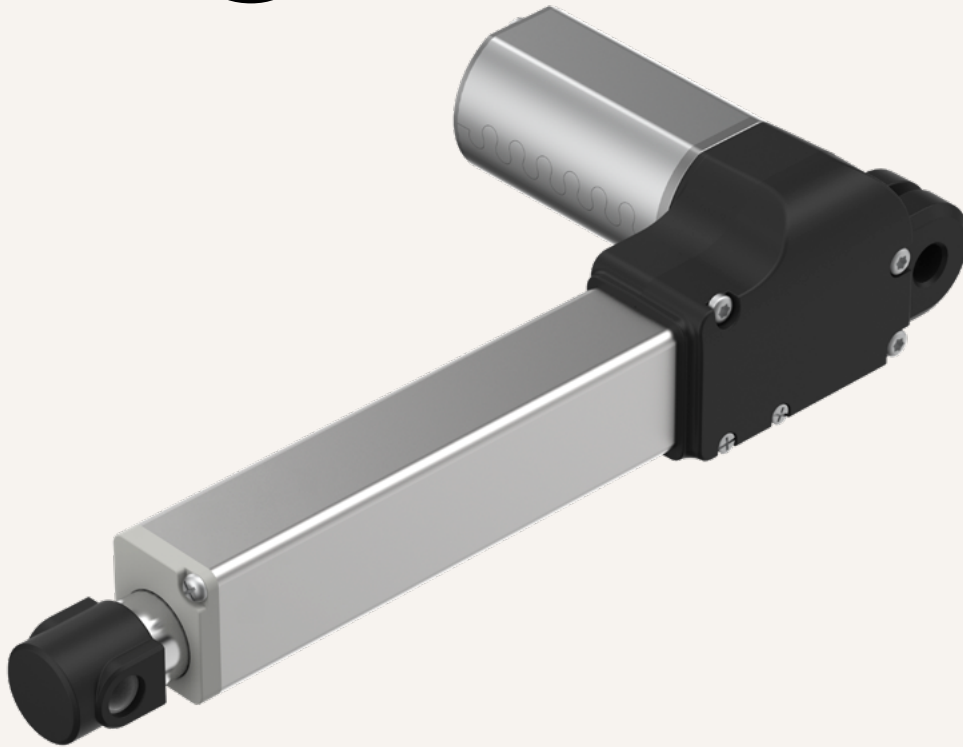

Product Segments

- **Comfort Motion**

TiMOTION's TA43 linear actuator can fulfill a manufacturer's seating requirement for small installation dimensions. Although small, this linear actuator provides great force. The compact design is merely 100mm, with a maximum stroke length of 300mm, yet can withstand a maximum pressure of 4000N.

General Features

Max. load	4,000N (push/pull)
Max. speed at max. load	2.5mm/s
Max. speed at no load	12.1mm/s
Retracted length	≥ Stroke + 100mm
Stroke	20~300mm
Options	Hall sensors
Voltage	24V DC; 24V DC (PTC)
Color	Black or grey
Operational temperature range	+5°C~+45°C

Drawing

Standard Dimensions
(mm)

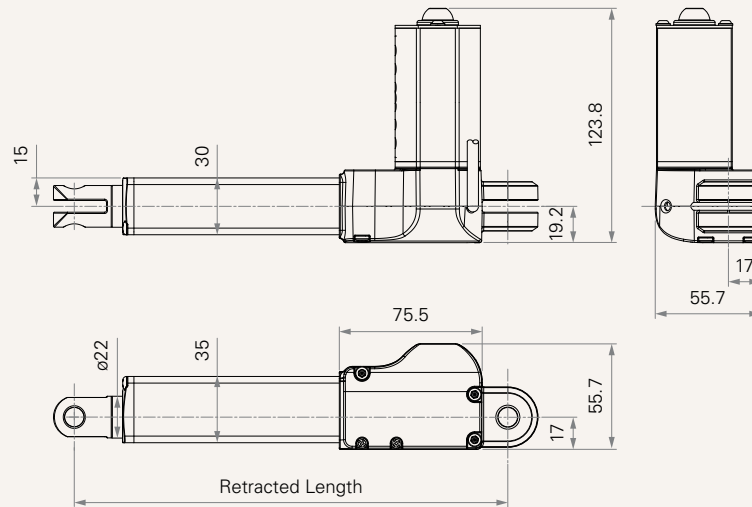

Load and Speed

CODE	Load (N)		Self Locking Force (N)	Typical Current (A)		Typical Speed (mm/s)	
	Push	Pull		No Load 32V DC	With Load 24V DC	No Load 32V DC	With Load 24V DC
Motor Speed (4100RPM, Duty Cycle 10%)							
C	3000	3000	3000	1.0	2.7	7.9	3.6
D	2000	2000	2000	1.0	2.7	12.1	5.4
Motor Speed (4500RPM, Duty Cycle 10%)							
B	4000	4000	4000	1.0	3.1	6.0	2.5
E	3000	3000	3000	1.0	3.1	8.5	5.0

Note

- 1 Please refer to the approved drawing for the final authentic value.
- 2 The current & speed in table are tested with 24V DC motor.
- 3 This self-locking force level is reached only when a short circuit is applied on the terminals of the motor. All the TiMOTION control boxes have this feature built-in.
- 4 The current & speed in table are tested when the actuator is extending under push load.
- 5 The data in the performance charts shows theoretical value using specific TiMOTION control boxes.
- 6 Standard stroke: Min. $\geq 20\text{mm}$, Max. please refer to below table. Please contact TiMOTION for more details.

CODE	Load (N)	Max Stroke (mm)
B, C, D, E	≤ 4000	300

Performance Data (24V DC Motor)

Motor Speed (4100RPM)

Speed vs. Load

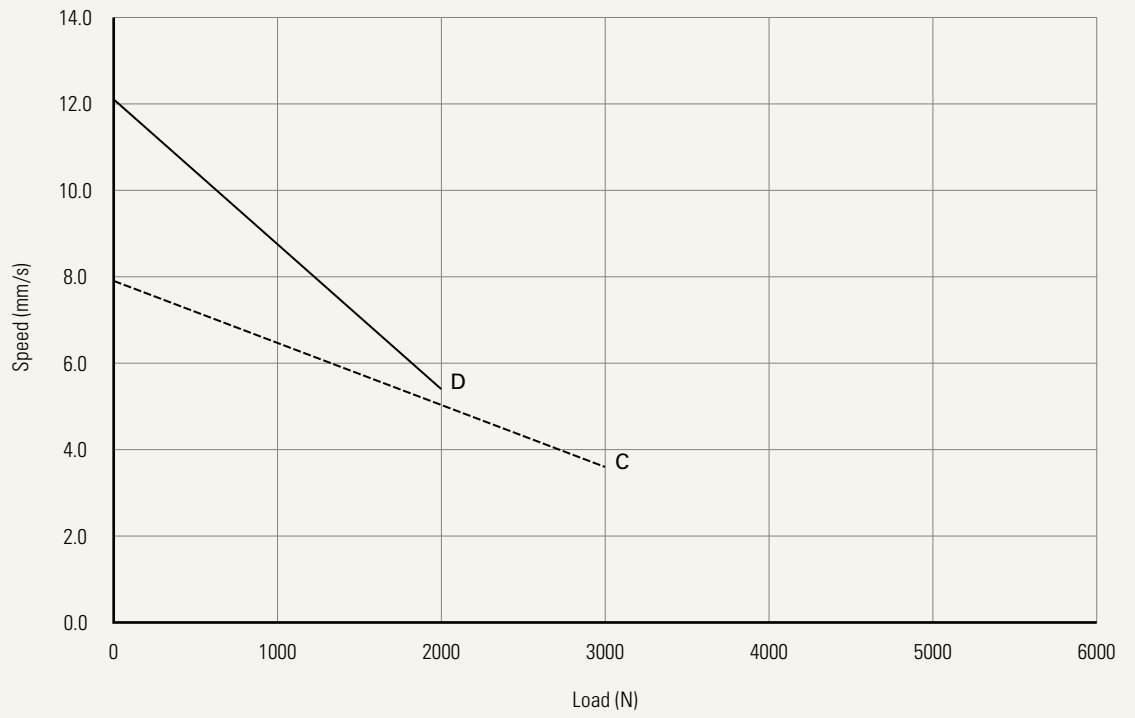

Current vs. Load

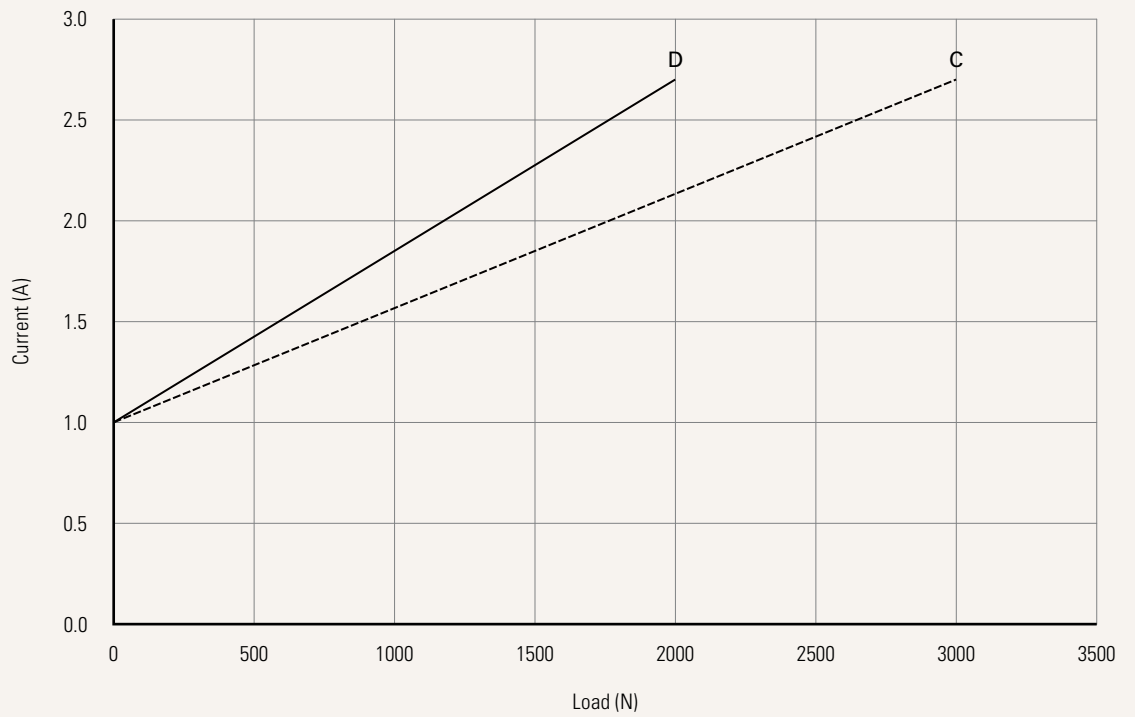

Performance Data (24V DC Motor)

Motor Speed (4500RPM)

Speed vs. Load

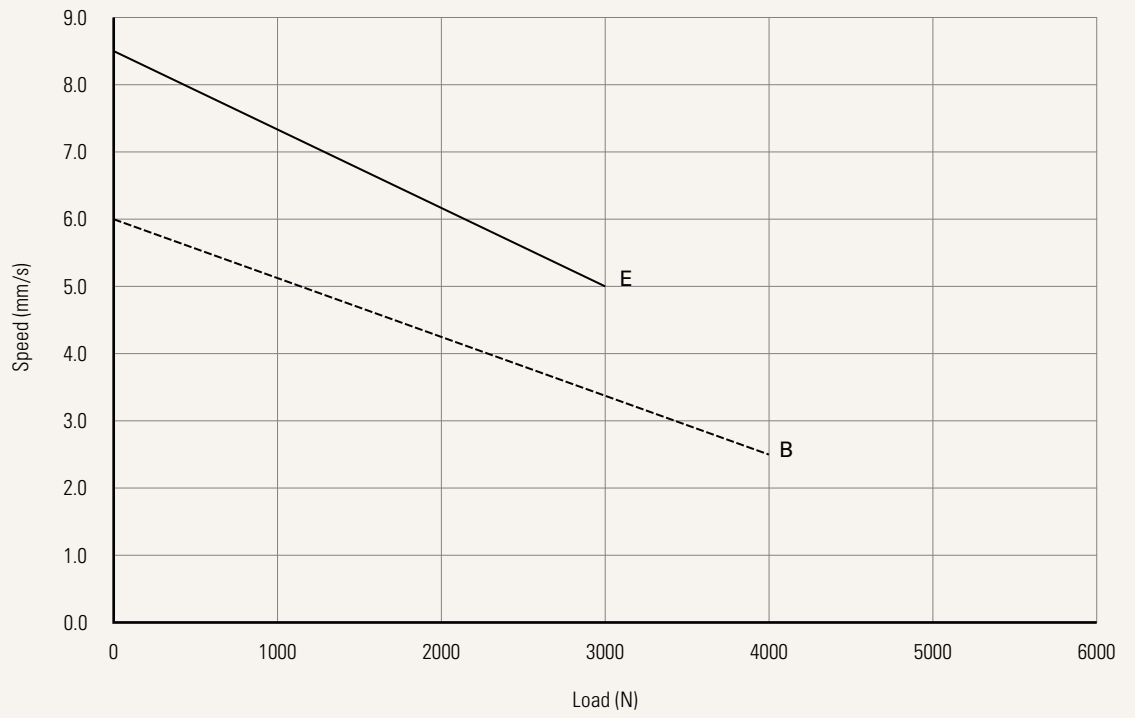

Current vs. Load

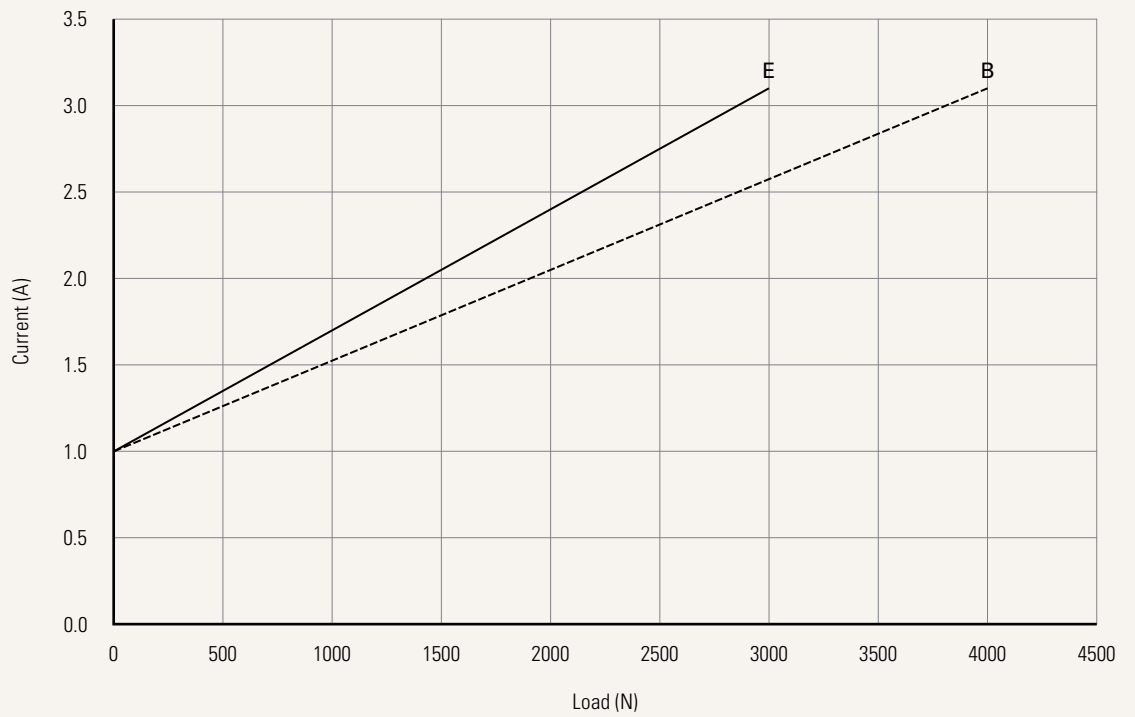

Voltage	2 = 24V DC	5 = 24V DC, PTC		
Load and Speed	See page 2			
Stroke (mm)	See page 2			
Retracted Length (mm)	See page 6			
Rear Attachment (mm)	1 = Plastic, U clevis, slot 6.2, depth 13.5, hole 8.2	2 = Plastic, U clevis, slot 6.2, depth 13.5, hole 10.2		
	See page 7			
Front Attachment (mm)	2 = Punched hole on inner tube + plastic cap, without slot, hole 10.2	7 = Aluminum casting, U clevis, width 6.2, depth 17.0, hole 8.2		
	5 = Plastic, without slot, hole 8.2, with plastic T-bushing	8 = Aluminum casting, U clevis, width 6.2, depth 17.0, hole 10.2		
	6 = Plastic, without slot, hole 10.2, with plastic T-bushing			
Direction of Rear Attachment (Counterclockwise)	2 = 0°			
	See page 7			
Color	1 = Black	2 = Pantone 428C		
IP Rating	1 = Without			
Special Functions for Spindle Sub-Assembly	0 = Without	2 = Push only		
Functions for Limit Switches	1 = Two switches at full retracted / extended positions to cut current	3 = Two switches at full retracted / extended positions to send signal		
	See page 8			
Output Signals	0 = Without	5 = Hall sensor*2		
Connector	1 = DIN 6P, 90° plug	C = Y cable (For direct cut system, water proof, anti pull)	E = Molex 8P, 180° plug	P = Molex 8P, 90° plug, without anti-clip
	2 = Tinned leads		F = DIN 6P, 180° plug	
	4 = Big 01P, plug			
Cable Length (mm)	0 = Straight, 100	3 = Straight, 1000	6 = Straight, 2000	B-H = For direct cut system. See page 8
	1 = Straight, 500	4 = Straight, 1250	7 = Curly, 200	
	2 = Straight, 750	5 = Straight, 1500	8 = Curly, 400	

Retracted Length (mm)

1. Calculate $A+B = Y$
2. Retracted length needs to \geq Stroke+Y

A.	
Front Attach.	Rear Attach.
	1, 2
2	+100
5, 6	+108
7, 8	+138

B.	
Stroke (mm)	
20~200	-
201~250	+5
251~300	+10

Rear Attachment (mm)

1 = Plastic, U clevis, slot 6.2, depth 13.5, hole 8.2

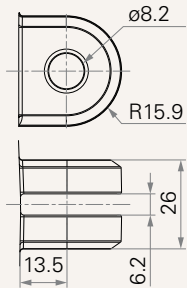

2 = Plastic, U clevis, slot 6.2, depth 13.5, hole 10.2

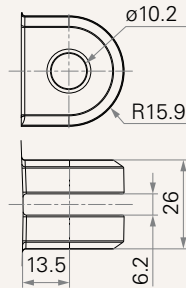

Front Attachment (mm)

2 = Punched hole on inner tube + plastic cap, without slot, hole 10.2

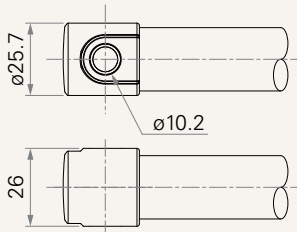

5 = Plastic, without slot, hole 8.2, with plastic T-bushing

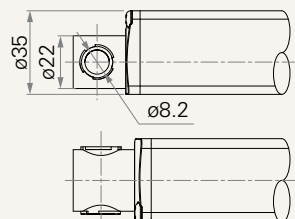

6 = Plastic, without slot, hole 10.2, with plastic T-bushing

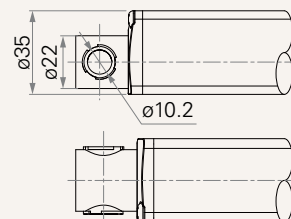

7 = Aluminum casting, U clevis, width 6.2, depth 17.0, hole 8.2

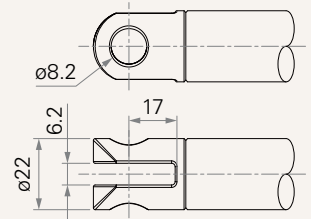

8 = Aluminum casting, U clevis, width 6.2, depth 17.0, hole 10.2

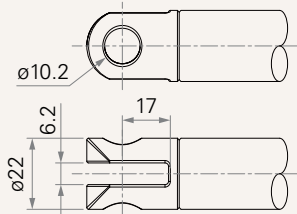

Direction of Rear Attachment (Counterclockwise)

2 = 0°

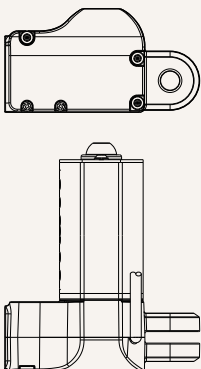

Functions for Limit Switches

Wire Definitions

CODE	Pin					
	● 1 (Green)	● 2 (Red)	○ 3 (White)	● 4 (Black)	● 5 (Yellow)	● 6 (Blue)
1	extend (VDC+)	N/A	N/A	N/A	retract (VDC+)	N/A
3	extend (VDC+)	common	upper limit switch	N/A	retract (VDC+)	lower limit switch

Connector

1 = DIN 6P, 90° plug

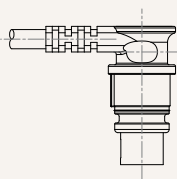

2 = Tinned leads

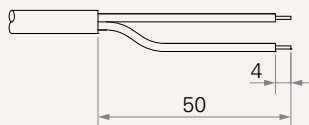

4 = Big 01P, plug

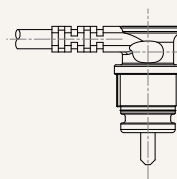

C = Y cable (For direct cut system, water proof, anti pull)

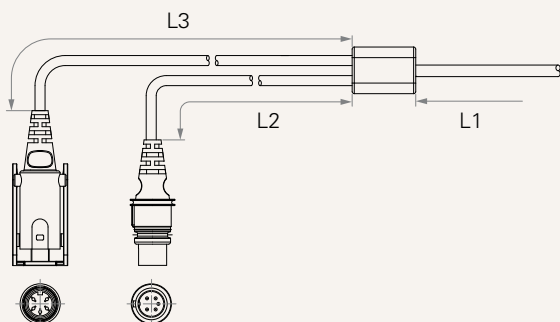

Cable Length for Direct Cut System (mm)

CODE	L1	L2	L3
B	100	100	100
C	100	1000	400
D	100	2700	500
E	1000	100	100
F	100	600	1000
G	1500	1000	1000
H	100	100	1200

E = Molex 8P, 180° plug

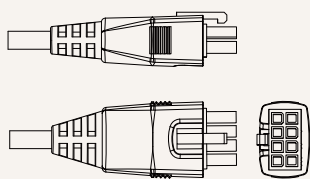

F = DIN 6P, 180° plug

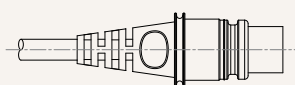

P = Molex 8P, 90° plug, without anti-clip

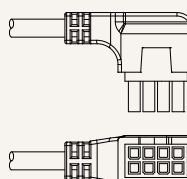

Terms of Use

The user is responsible for determining the suitability of TiMOTION products for a specific application. TiMOTION products are subject to change without prior notice.