

TA42

series

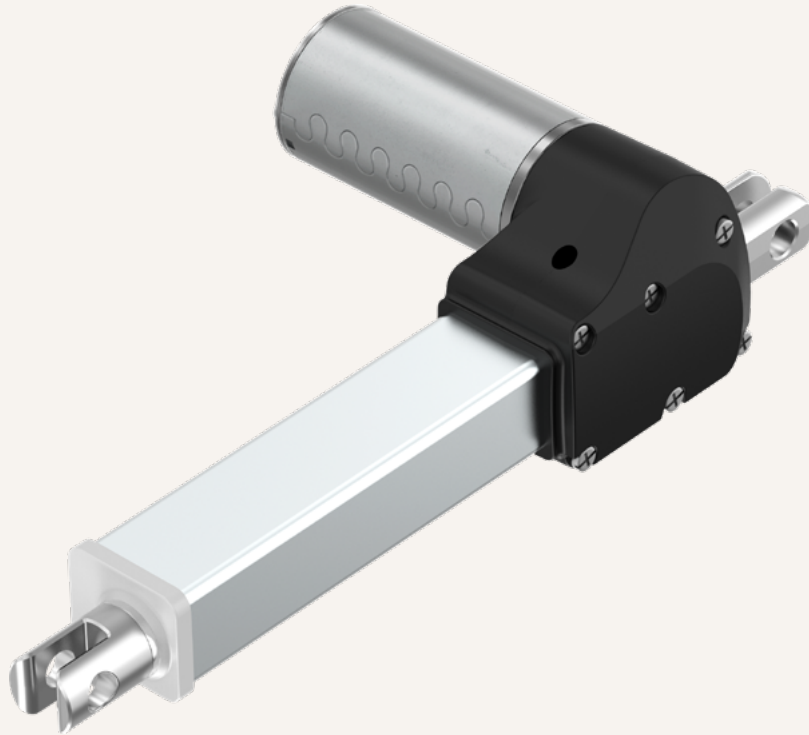

Product Segments

- **Comfort Motion**

TiMOTION's TA42 linear actuator can fulfill a manufacturer's seating requirement for small installation dimensions. It comes without any motor housing, which can save on space while being installed in the recliner. TA42's compact design is only 100mm. It has a maximum stroke length of 200mm, yet it can withstand a maximum pressure of 1500N, which can be perfect for the head position adjustment for recliners.

General Features

Max. load	1,500N (push/pull)
Max. speed at max. load	6.2mm/s
Max. speed at no load	13.2mm/s
Retracted length	≥ Stroke + 100mm
Stroke	25~200mm
Options	Push only
Voltage	24V DC; 24V DC (PTC)
Color	Black or grey
Operational temperature range	+5°C~+45°C
Suitable for recliner applications	

Drawing

Standard Dimensions
(mm)

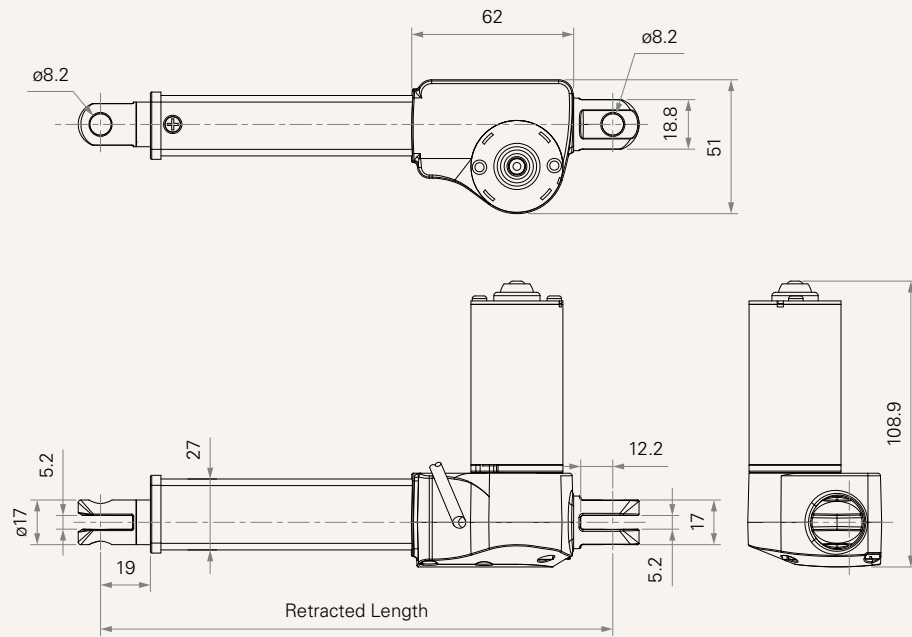

Load and Speed

CODE	Load (N)		Typical Current (A)		Typical Speed (mm/s)	
	Push	Pull	No Load 32V DC	With Load 24V DC	No Load 32V DC	With Load 24V DC
Motor Speed (5000RPM, Duty Cycle 10%)						
D	1500	1500	0.6	1.6	9.2	4.6
E	1500	1500	0.6	1.9	13.2	6.2

Note

- 1 Please refer to the approved drawing for the final authentic value.
- 2 The current & speed in table are tested with 24V DC motor.
- 3 This self-locking force level is reached only when a short circuit is applied on the terminals of the motor. All the TiMOTION control boxes have this feature built-in.
- 4 The current & speed in table are tested when the actuator is extending under push load.
- 5 The data in the performance charts shows theoretical value using specific TiMOTION control boxes. Please contact TiMOTION for more details.
- 6 Standard stroke: Min. ≥ 25mm, Max. please refer to below table.

CODE	Load (N)	Max Stroke (mm)
D,E	≤ 1500	200

Performance Data (24V DC Motor)

Motor Speed (5000RPM, Duty Cycle 10%)

Speed vs. Load

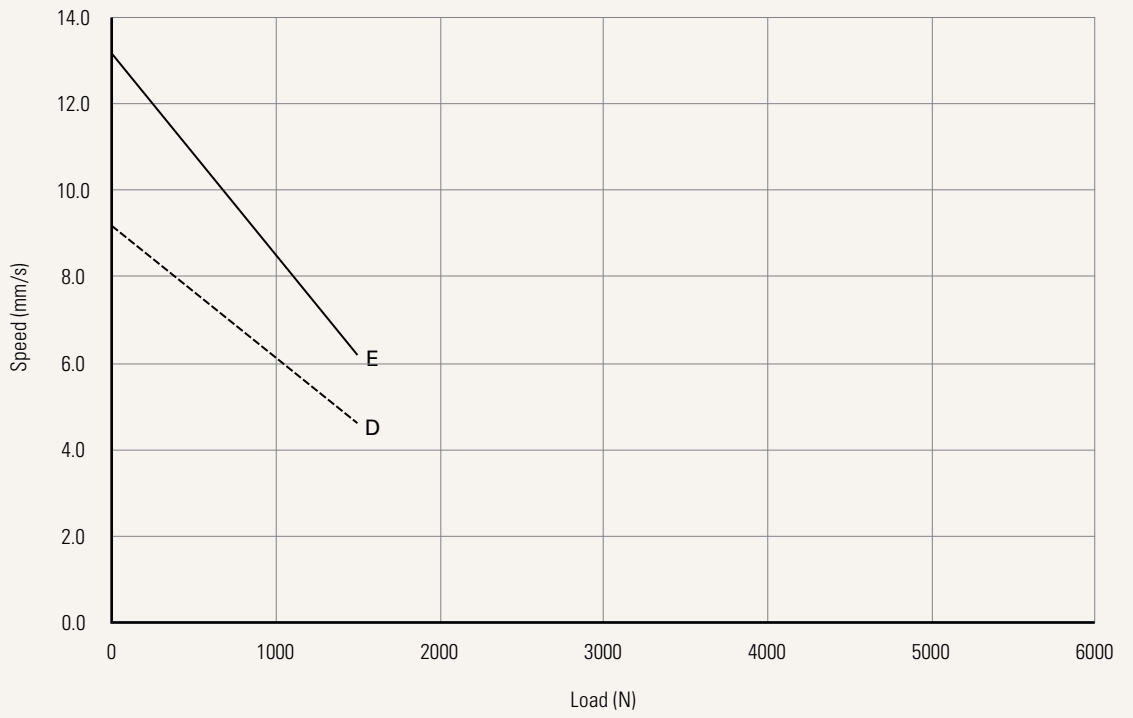

Current vs. Load

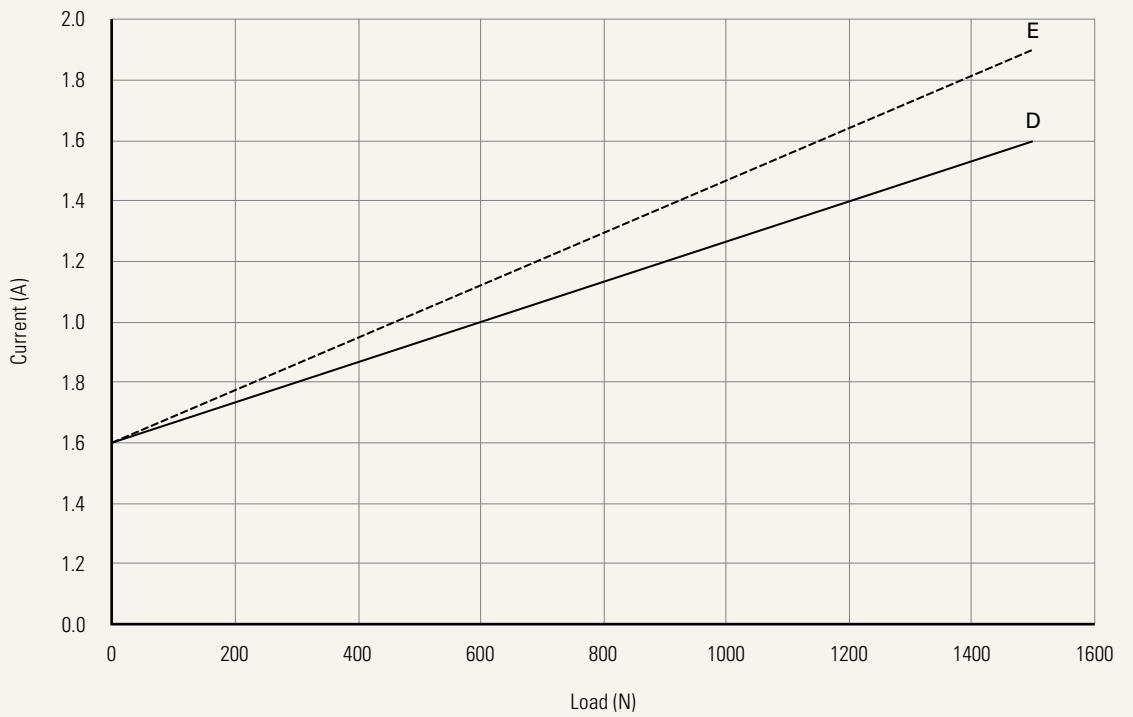

Voltage	2 = 24V DC	5 = 24V DC, PTC	
Load and Speed	See page 2		
Stroke (mm)	See page 2		
Retracted Length (mm)	See page 5		
Rear Attachment (mm) See page 5	N = Plastic, U clevis, one piece, slot 6, depth 13, hole 10 E = Aluminum casting, U clevis, slot 5.2, depth 12.2, hole 6.2 G = Aluminum casting, U clevis, slot 5.2, depth 12.2, hole 8.2		
Front Attachment (mm) See page 5	N = Plastic, U clevis, slot 7, depth 20, hole 10 E = Aluminum casting, U clevis, slot 5.2, depth 12.2, hole 6.2 G = Aluminum casting, U clevis, slot 5.2, depth 12.2, hole 8.2		
Direction of Rear Attachment (Counterclockwise) See page 6	1 = 0°	3 = 90°	
Color	1 = Black + 428C retaining ring	2 = Pantone 428C + 428C retaining ring	
IP Rating	1 = Without		
Special Functions for Spindle Sub-Assembly	0 = Without	2 = Push only	
Functions for Limit Switches See page 6	1 = Two switches at full retracted / extended positions to cut current 3 = Two switches at full retracted / extended positions to send signal		
Output Signals	0 = Without		
Connector See page 6	1 = DIN 6P, 90° plug	2 = Tinned leads	P = Molex 8P, without anti-clip, 90° plug
Cable Length (mm)	0 = Straight, 100 1 = Straight, 500 2 = Straight, 750	3 = Straight, 1000 4 = Straight, 1250 5 = Straight, 1500	6 = Straight, 2000 7 = Curly, 200 8 = Curly, 400

Retracted Length (mm)

1. Calculate $A+B = Y$
2. Retracted length needs to \geq Stroke+Y

A.		
Front Attach.	Rear Attach.	
	E,G	N
E,G	+100	+98
N	+117	+115

B. Stroke (mm)	
25-200	-

Rear Attachment (mm)

N = Plastic, U clevis, one piece, slot 6, depth 13, hole 10

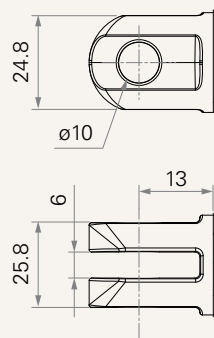

E = Aluminum casting, U clevis, slot 5.2, depth 12.2, hole 6.2

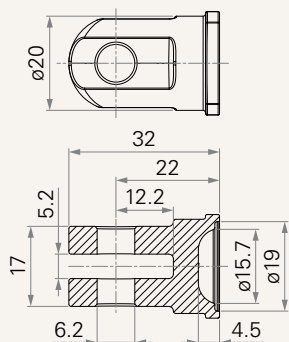

G = Aluminum casting, U clevis, slot 5.2, depth 12.2, hole 8.2

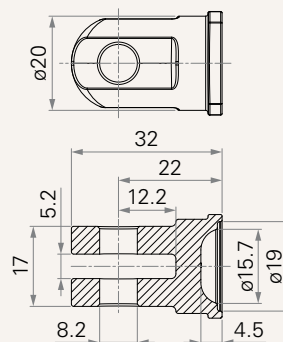

Front Attachment (mm)

N = Plastic, U clevis, slot 7, depth 20, hole 10

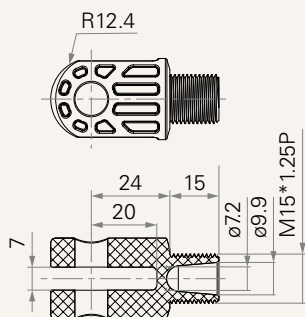

E = Aluminum casting, U clevis, slot 5.2, depth 12.2, hole 6.2

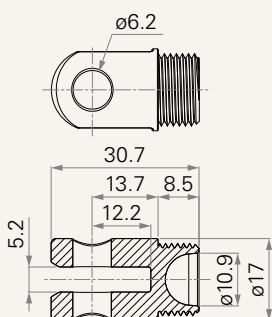

G = Aluminum casting, U clevis, slot 5.2, depth 12.2, hole 8.2

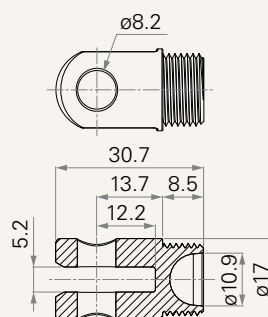

Direction of Rear Attachment (Counterclockwise)

1 = 0°

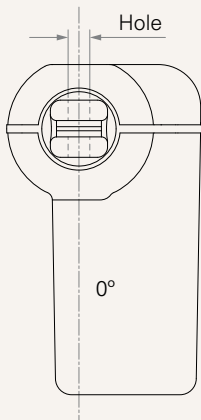

3 = 90°

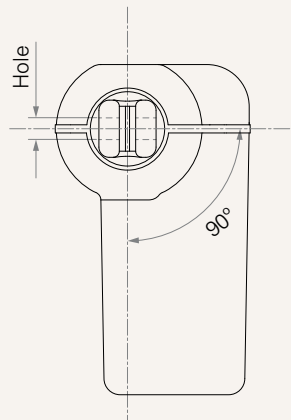

Functions for Limit Switches

Wire Definitions

CODE	Pin					
	● 1 (Green)	● 2 (Red)	○ 3 (White)	● 4 (Black)	● 5 (Yellow)	● 6 (Blue)
1	extend (VDC+)	N/A	N/A	N/A	retract (VDC+)	N/A
3	extend (VDC+)	common	upper limit switch	N/A	retract (VDC+)	lower limit switch

Connector

1 = DIN 6P, 90° plug

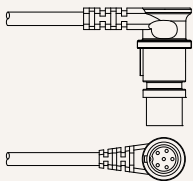

2 = Tinned leads

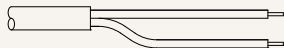

P = Molex 8P, without anti-clip, 90° plug

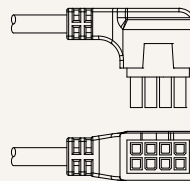

Terms of Use

The user is responsible for determining the suitability of TiMOTION products for a specific application. TiMOTION products are subject to change without prior notice.