

SIZE 17 HIGH PERFORMANCE STEPPER MOTOR DATA

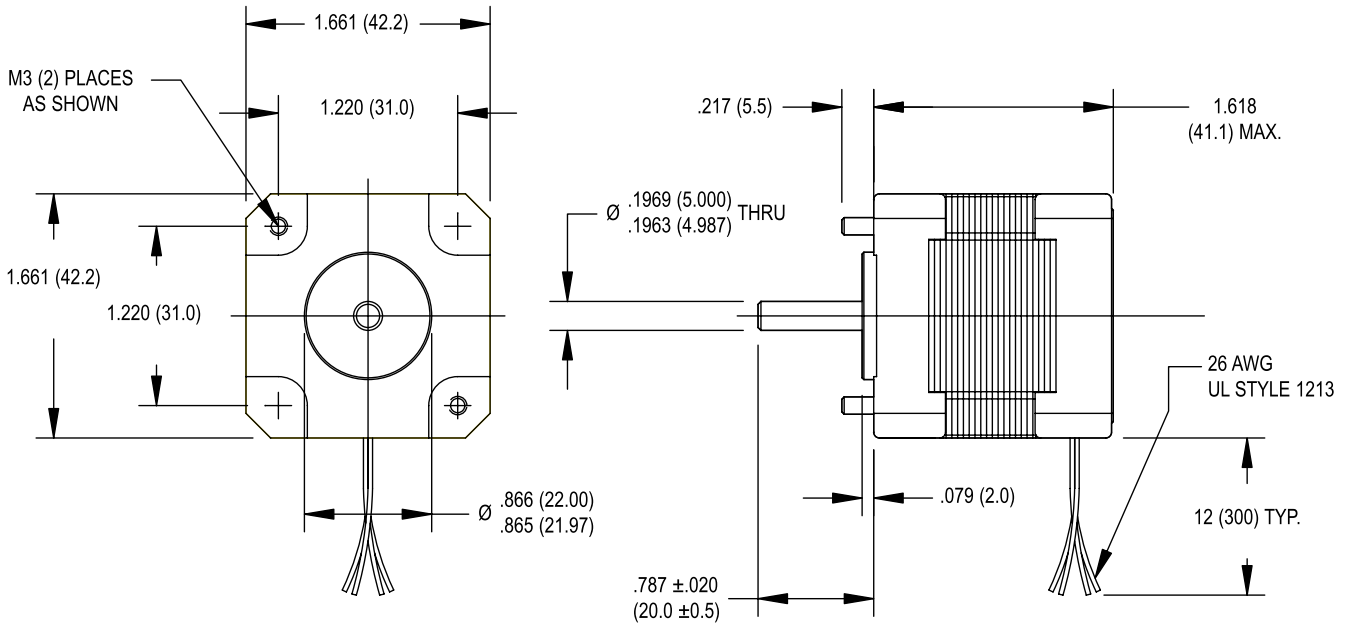

Specification	Units	HS 200 1716		
		0033	0100	0150
Rated Phase Current	A	0.33	1.00	1.50
Phase Resistance	Ω	27.2	2.86	1.40
Phase Inductance	mH	66.7	6.74	3.25
Holding Torque Unipolar	oz-in Ncm	—	—	—
Holding Torque Bipolar	oz-in Ncm	47 33	47 33	47 33
Detent Torque	oz-in Ncm	2.3 1.6	2.3 1.6	2.3 1.6
Rotor Inertia	oz-in-s ² $\times 10^{-4}$ g-cm ²	9.3 66	9.3 66	9.3 66
Motor Weight (Mass)	lb kg	0.66 0.30	0.66 0.30	0.66 0.30
Maximum Voltage	V	40	40	40
Std. No. of Leads	—	4	4	4

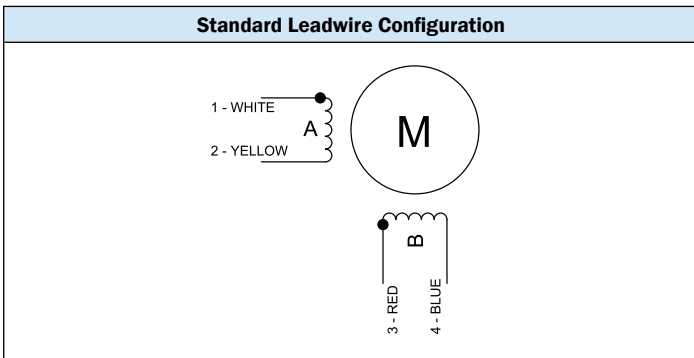
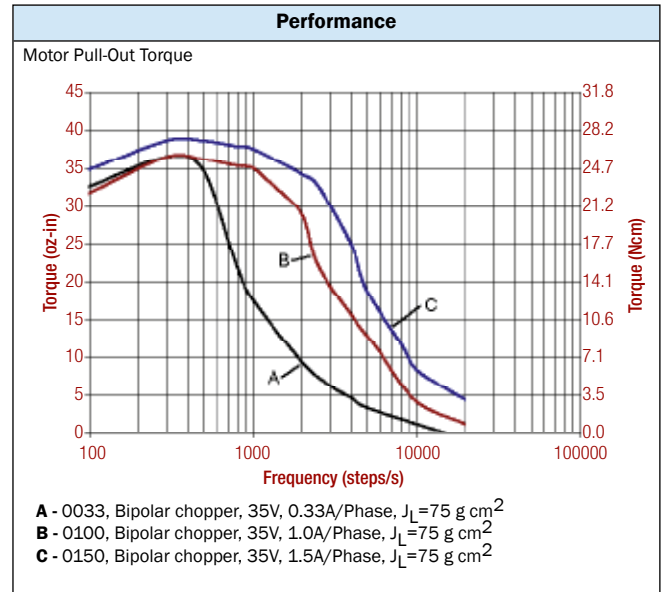

- ### Standard Features
- Step angle: 1.8°
 - Step angle accuracy: 5%
 - Insulation class: B (130°C)
 - Optimized for microstep operation
 - NEMA 17 mounting configuration
 - Neodymium magnets
 - Additional windings and customization options available

- ### Complementary Products
- Gearboxes
 - Encoders