



Fast, Accurate, Smooth Motion

Open Loop Stepping System EtherCAT Network

User Manual

- Ezi-STEP II EtherCAT

Contents

| | |
|--|-----------|
| Contents | 2 |
| Introduction | 6 |
| Before Operation | 6 |
| Safety Precautions | 7 |
| 1 Product Specification | 10 |
| 1.1 Model Naming | 11 |
| 1.2 Product Dimension | 12 |
| 1.3 EtherCAT Specifications | 13 |
| 1.4 Drive Specification | 14 |
| 2 Installation | 15 |
| 2.1 Precautions of Installation | 16 |
| 2.2 System Configuration | 17 |
| 2.3 External Wiring Diagram | 19 |
| 2.4 Appearance and Part Name | 21 |
| 2.4.1 EtherCAT ID | 22 |
| 2.4.2 EtherCAT Status LED | 23 |
| 2.4.3 EtherCAT Communication Connection | 24 |
| 2.4.4 I/O Connector | 25 |
| 2.4.5 Encoder Connection Connector | 26 |
| 2.4.6 Motor Connection Connector | 26 |
| 2.4.7 Power Connection Connector | 26 |
| 2.4.8 USB Connector | 27 |
| 2.5 Appendix | 27 |
| 2.5.1 Extension Cable for Motor | 27 |
| 2.5.2 Extension Cable for Encoder | 28 |
| 2.5.3 Connector Specifications | 29 |
| 3 EtherCAT Communication | 30 |
| 3.1 CAN application protocol over EtherCAT | 31 |
| 3.1.1 Object Dictionary | 31 |
| 3.1.2 Mailbox Communication | 31 |
| 3.1.3 Process Data Communication | 32 |
| 3.2 PDO Mapping | 32 |
| 3.2.1 PDO Mapping | 32 |
| 3.2.2 PDO Assign | 32 |
| 3.3 EtherCAT State Machine | 33 |
| 3.4 Synchronization | 34 |
| 3.4.1 Free Run | 34 |
| 3.4.2 SM Event | 34 |
| 3.4.3 DC Sync Event | 34 |
| 3.5 EtherCAT Slave Information | 35 |
| 4 CiA402 Drive Profile | 36 |
| 4.1 Drive Status Control | 37 |

| | | |
|----------|-----------------------------------|-----------|
| 4.1.1 | Control word | 39 |
| 4.1.2 | Status word | 39 |
| 4.2 | Error Code | 41 |
| 4.3 | Mode of operation | 43 |
| 4.4 | Cyclic Synchronous Position Mode | 44 |
| 4.4.1 | Definition | 44 |
| 4.4.2 | Related Objects | 44 |
| 4.4.3 | Control word and Status word | 44 |
| 4.5 | Profile Position Mode | 46 |
| 4.5.1 | Definition | 46 |
| 4.5.2 | Related Objects | 46 |
| 4.5.3 | Control word and Status word | 46 |
| 4.5.4 | Position movement method | 47 |
| 4.6 | Homing Mode | 50 |
| 4.6.1 | Definition | 50 |
| 4.6.2 | Relative Objects | 50 |
| 4.6.3 | Control word and Status word | 50 |
| 4.6.4 | Origin Search Method | 51 |
| 4.7 | Touch Probe | 55 |
| 4.7.1 | Definition | 55 |
| 4.7.2 | Related Objects | 55 |
| 4.7.3 | Touch Probe Status and Control | 55 |
| 4.8 | Digital Input and Output | 57 |
| 4.8.1 | Definition | 57 |
| 4.8.2 | Related Objects | 57 |
| 4.8.3 | User I/O | 57 |
| 4.8.4 | ORIGIN and LIMIT Input | 57 |
| 4.8.5 | BRAKE Output | 58 |
| 4.9 | Safety Function | 58 |
| 4.9.1 | Operation of Safety Function | 59 |
| 5 | Operation | 61 |
| 5.1 | Operation Sequence | 62 |
| 5.2 | Setting | 62 |
| 5.2.1 | Installation | 62 |
| 5.2.2 | Wiring | 62 |
| 5.2.3 | Input Power | 62 |
| 5.2.4 | PDO Mapping | 62 |
| 5.2.5 | Set Communication Status | 63 |
| 5.3 | Operation | 63 |
| 5.3.1 | Drive Status Control | 63 |
| 5.3.2 | Set Mode | 63 |
| 5.3.3 | Set Operation | 63 |
| 5.3.4 | Movement Command | 63 |
| 5.3.5 | Check Statuses | 63 |
| 5.4 | Drive Setting Adjustment | 64 |
| 5.4.1 | Change Rotation Direction | 64 |
| 5.4.2 | Change I/O Signal Level | 64 |
| 6 | EtherCAT Object Dictionary | 65 |
| 6.1 | Indication Type of Objects | 66 |
| 6.1.1 | Index and Sub-Index | 66 |
| 6.1.2 | Name | 66 |
| 6.1.3 | Data Type | 66 |
| 6.1.4 | Access | 67 |
| 6.1.5 | SAVE | 67 |
| 6.1.6 | PDO Mapping | 67 |
| 6.1.7 | Constant Value | 67 |

| | | |
|--------|---|----|
| 6.1.8 | Value Range | 67 |
| 6.1.9 | Default Value | 67 |
| 6.2 | Communication Object | 68 |
| 6.2.1 | Object 1000h: Device type | 68 |
| 6.2.2 | Object 1001h: Error register | 68 |
| 6.2.3 | Object 1008h: Device name | 68 |
| 6.2.4 | Object 1009h: Hardware version | 68 |
| 6.2.5 | Object 100Ah: Software version | 68 |
| 6.2.6 | Object 1010h: Store parameters | 69 |
| 6.2.7 | Object 1011h: Restore default parameters | 69 |
| 6.2.8 | Object 1018h: Identity | 70 |
| 6.2.9 | Object 10F1h: Error settings | 70 |
| 6.2.10 | Object 10F3h: Diagnosis history | 71 |
| 6.3 | PDO Mapping Object | 73 |
| 6.3.1 | Object 1600h: RxPDO-Map 0 | 73 |
| 6.3.2 | Object 1601h: RxPDO-Map 1 | 73 |
| 6.3.3 | Object 1A00h: TxPDO-Map 0 | 73 |
| 6.3.4 | Object 1A01h: TxPDO-Map 1 | 74 |
| 6.3.5 | Object 1C12h: RxPDO assign | 74 |
| 6.3.6 | Object 1C13h: TxPDO assign | 74 |
| 6.4 | Sync Manager Object | 75 |
| 6.4.1 | Object 1C00h: Sync manager type | 75 |
| 6.4.2 | Object 1C32h: SM output parameter | 75 |
| 6.4.3 | Object 1C33h: SM input parameter | 75 |
| 6.5 | Drive Profile Object | 76 |
| 6.5.1 | Object 603Fh: Error code | 76 |
| 6.5.2 | Object 6040h: Control word | 76 |
| 6.5.3 | Object 6041h: Status word | 76 |
| 6.5.4 | Object 605Ah: Quick stop option code | 76 |
| 6.5.5 | Object 605Bh: Shutdown option code | 77 |
| 6.5.6 | Object 605Ch: Disable operation option code | 77 |
| 6.5.7 | Object 605Dh: Halt option code | 77 |
| 6.5.8 | Object 605Eh: Fault reaction option code | 78 |
| 6.5.9 | Object 6060h: Mode of operation | 78 |
| 6.5.10 | Object 6061h: Mode of operation display | 78 |
| 6.5.11 | Object 6062h: Position demand value | 78 |
| 6.5.12 | Object 6064h: Position actual value | 78 |
| 6.5.13 | Object 606Bh: Velocity demand value | 79 |
| 6.5.14 | Object 606Ch: Velocity actual value | 79 |
| 6.5.15 | Object 607Ah: Target position | 79 |
| 6.5.16 | Object 607Ch: Home offset | 79 |
| 6.5.17 | Object 607Dh: Software position limit | 79 |
| 6.5.18 | Object 607Eh: Polarity | 80 |
| 6.5.19 | Object 607Fh: Max profile velocity | 80 |
| 6.5.20 | Object 6081h: Profile velocity | 80 |
| 6.5.21 | Object 6083h: Profile acceleration | 81 |
| 6.5.22 | Object 6084h: Profile deceleration | 81 |
| 6.5.23 | Object 6098h: Homing method | 81 |
| 6.5.24 | Object 6099h: Homing speeds | 81 |
| 6.5.25 | Object 609Ah: Homing acceleration | 82 |
| 6.5.26 | Object 60B8h: Touch probe function | 82 |
| 6.5.27 | Object 60B9h: Touch probe status | 82 |
| 6.5.28 | Object 60BAh: Touch probe 1 positive value | 83 |
| 6.5.29 | Object 60BBh: Touch probe 1 negative value | 83 |
| 6.5.30 | Object 60BCh: Touch probe 2 positive value | 83 |
| 6.5.31 | Object 60BDh: Touch probe 2 negative value | 83 |
| 6.5.32 | Object 60C2h: Interpolation time period | 84 |
| 6.5.33 | Object 60D0h: Touch probe source | 84 |

| | | |
|--------|---|----|
| 6.5.34 | Object 60D5h: Touch probe 1 positive edge counter | 84 |
| 6.5.35 | Object 60D6h: Touch probe 1 negative edge counter | 84 |
| 6.5.36 | Object 60D7h: Touch probe 2 positive edge counter | 84 |
| 6.5.37 | Object 60D8h: Touch probe 2 negative edge counter | 85 |
| 6.5.38 | Object 60E3h: Supported homing methods | 85 |
| 6.5.39 | Object 60F4h: Following error actual value | 85 |
| 6.5.40 | Object 60FDh: Digital inputs | 85 |
| 6.5.41 | Object 60FEh: Digital outputs | 86 |
| 6.5.42 | Object 6502h: Supported drive modes | 87 |
| 6.6 | Manufacture specific Object | 88 |
| 6.6.1 | Object 2001h: Sensors logics | 88 |
| 6.6.2 | Object 2002h: Reverse limit direction | 88 |
| 6.6.3 | Object 2003h: Limit stop method | 89 |
| 6.6.4 | Object 2004h: External Encoder | 89 |
| 6.6.5 | Object 2006h: Start speed | 90 |
| 6.6.6 | Object 2007h: Run current | 90 |
| 6.6.7 | Object 2008h: Boost current | 91 |
| 6.6.8 | Object 2009h: Stop current | 91 |
| 6.6.9 | Object 200Ah: Motor number | 92 |
| 6.6.10 | Object 200Ch: Reference resolution | 92 |
| 6.6.11 | Object 200Fh: Encoder filter time | 92 |
| 6.6.12 | Object 2010h: Brake delay | 93 |
| 6.6.13 | Object 2011h: Digital input levels | 93 |
| 6.6.14 | Object 2012h: Digital output levels | 93 |
| 6.6.15 | Object 201Bh: Limit Deceleration | 94 |
| 6.6.16 | Object 2020h: Error code history setting | 94 |
| 6.6.17 | Object 2021h: Error code history | 94 |
| 6.6.18 | Object 2025h: Lifetime Record | 96 |
| 6.6.19 | Object 2030h: Advanced settings | 97 |
| 6.6.20 | Object 2040h: Safety Mode | 98 |

Changelog

101

Introduction

Before Operation

- Thank you for your purchasing Ezi-STEP II EtherCAT.
- 32 Bit high-performance of ARM Processor on-board Ezi-STEP II EtherCAT is motion controller supports Field-network EtherCAT.
- This manual describes handling, safety instruction, diagnosis and troubleshooting of Ezi-STEP II EtherCAT.
- Before operating Ezi-STEP II EtherCAT, thoroughly read this manual.
- After reading the manual, keep the manual near the product so that any user can read the manual whenever needed.

Safety Precautions

General Precautions

- Contents of this manual are subject to change without prior notice for functional improvement, change of specifications or user's better understanding.
- When the manual is damaged or lost, please contact with Fastech's agents or our company to get a manual again.
- It is not responsible for Fastech to guarantee product randomly reconstructed because this kind of improper action is out of range of guarantee.

Safety Precautions

Before installation, operation and repairing, thoroughly read the manual and fully understand the contents. Also before operation, please understand the mechanical characteristics of the product and related safety information and precautions.

User manual describes level of precaution for safety as Warning and Danger.

Warning

If user does not properly handle the product, the user may seriously or slightly injured and damages may occur in the machine.



Danger

If user does not properly handle the product, a dangerous situation (such as an electric shock) may occur resulting in deaths or serious injuries.



Information

Necessary Information and extra attentions for operation.



Although precaution is only a **Warning**, a serious result could be caused depending on the situation.

Check the product

Warning

Check the product is damaged or parts are missing. Otherwise, the machine may get damaged or the user may get injured.



Installation

Warning

Carefully operate the product. Otherwise the product may get damaged or user's foot may get injured by dropping the product.

Use non-flammable materials such as metal in the place where the product is to be installed. Otherwise, a fire may occur.

When installing several units of FASTECH Co., Ltd.'s products in a sealed place, install a cooling fan to keep the ambient temperature as 50°C or lower. Otherwise a fire or other kinds of accidents may occur due to overheating.



Danger

The process of installation, Connection, Operation, Checking and Repairing should be done with qualified person.



Connect Cables

Warning

Keep the rated range of input voltage of the drive. Otherwise, a fire or other kinds of accidents may occur.

Please follow the wiring diagram for cable connection. Otherwise, a fire or other kinds of accidents may occur.



Danger

Before connecting cables, please check if input power is OFF. Otherwise, a fire or other kinds of accidents may occur.

The case of Ezi-STEP II EtherCAT is insulated from the ground of the internal circuit by the condenser so please ground the product. Otherwise, an electric shock or a fire may occur.



Operation and Setting

Warning

If a protection function (alarm) occurs, firstly remove its cause and then release (alarm reset) the protection function. If you operate continuously without removal of root cause, the machine may get damaged or the user may get injured.

Make all input signals to OFF before supply input voltage to drive. Motor will run then the machine may get damaged or the user may get injured.

All parameter values of Ezi-STEP II EtherCAT are set by default factory setting value. Change this value after reading this manual thoroughly. Otherwise, the machine may get damaged or other kinds of accidents may occur.



Check and Repair

Danger

Stop to supply power to main circuit and wait for a while before checking or repairing the Ezi-STEP II EtherCAT. Electricity remains in the capacitor may cause danger as like electric shock.

Do not change cabling while power is being supplied. Otherwise, the user may get injured or the product may get damaged.

Do not reconstruct the product. Otherwise, an electric shock may occur or the reconstructed product can not get After Sales Service.



Chapter 1

Product Specification

1.1 Model Naming

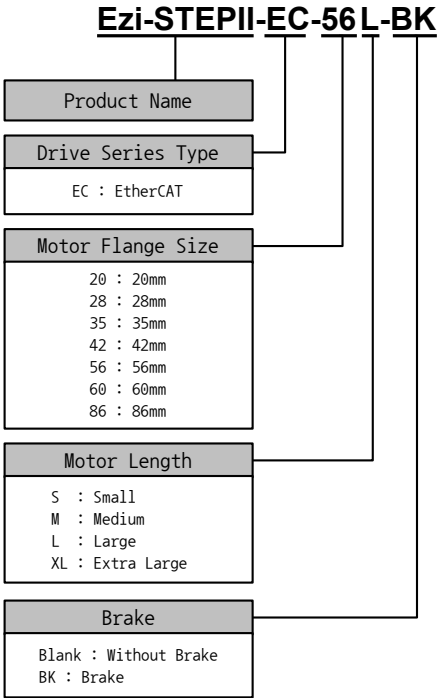

Figure 1.1: Model Naming

1.2 Product Dimension

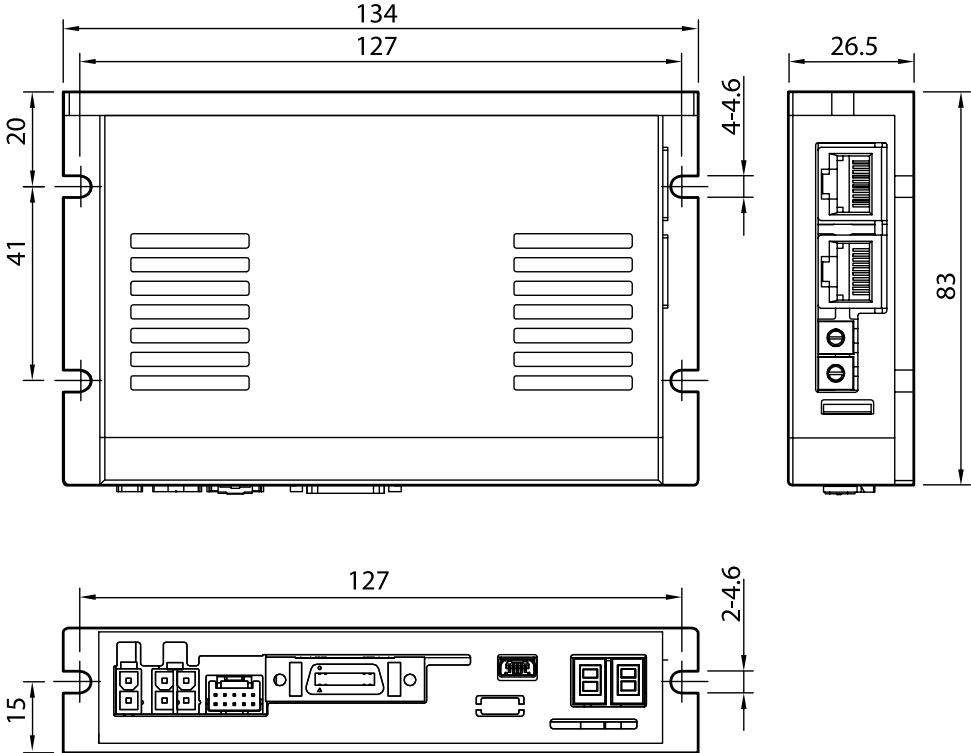

Figure 1.2: Dimensions of Ezi-STEP II EtherCAT

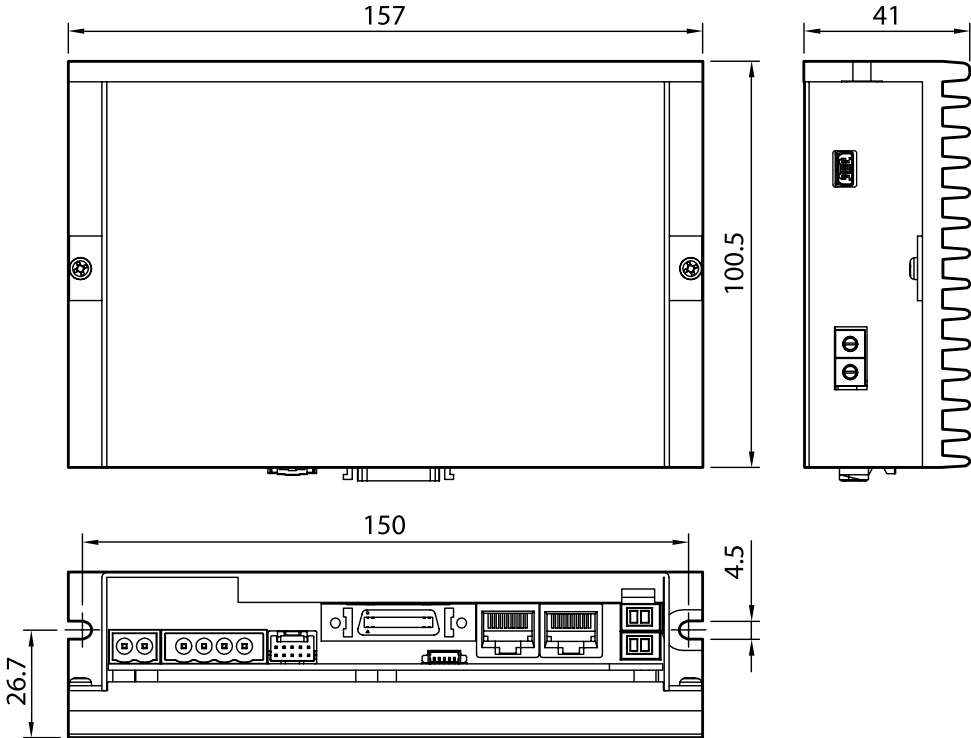

Figure 1.3: Dimensions of Ezi-STEP II EtherCAT 86

1.3 EtherCAT Specifications

| | |
|--------------------------|---|
| Type of Communication | EtherCAT |
| Physical Layer | Ethernet - 100BASE-TX |
| Connector | RJ45 (shielded) ECAT IN : EtherCAT Input ECAT OUT : EtherCAT Output |
| ECAT Device ID | Set Configured Station Alias by ECAT ID Switch : 1 ~ 99 Set Physical Address at Master : 1 ~ 65535 |
| Topology | Line (Structured by Products only) Tree, Star (When use Junction products) |
| Support Protocol | CoE (CANopen application protocol over EtherCAT) FoE (File Access over EtherCAT) |
| Control Profile | CiA402 drive profile (IEC61800-7) |
| Supported Operation Mode | Cyclic Synchronous Position Mode Profile Position Mode Homing Mode |
| Synchronization | Free Run, SM Event, DC SYNC Event (minimum cycle time: 250us) |
| Processing Data | Configurable PDO Mapping |

Table 1.1: Communication Specification

1.4 Drive Specification

| | | | |
|---------------------|----------------------|--|------------------------|
| Model | | Ezi-STEPII EtherCAT | Ezi-STEPII EtherCAT 86 |
| Input Voltage | | 24VDC \pm 10% | 40 ~ 70VDC |
| Control Method | | Bipolar PWM drive with 32bit MCU | |
| Current Consumption | | Max 500mA (Except motor current) | |
| Operating Condition | Ambient Temperature | In Use : 0 ~ 50°C In Storage : -20 ~ 70°C | |
| | Humidity | In Use : 35 ~ 85%RH (Non-Condensing) In Storage : 10 ~ 90%RH (Non-Condensing) | |
| | Vib. Resist. | 0.5g | |
| Function | Rotation Speed | 0 ~ 3,000 [rpm] | |
| | Resolution [ppr] | 500 ~ 100,000 pulse (Selectable by parameter) | |
| | Protection Functions | Over Current Error, Over Speed Error, Over Temperature Error, Over Regenerated Voltage Error, Motor Connect Error, ROM Error | |
| | LED Display | Power status, Alarm status, Run status, STEP On status | |
| I/O Signal | Input Signals | 3 dedicated input (LIMIT+, LIMIT-, ORIGIN) 7 user inputs (Photocoupler Input) | |
| | Output Signals | Brake 6 user outputs (Photocoupler Output) | |

Table 1.2: Drive Specification

Chapter 2

Installation

2.1 Precautions of Installation

1. This product designed for indoor usage and the ambient temperature of the room should be 0 ~ 50°C.
2. If temperature of the case is 50°C, radiate the outside to cool down.
3. Do not install this product under direct rays or near magnetic or radioactive objects.
4. If more than 2 drives are installed in a line, keep the interval of 20mm or more vertically and 50mm or more horizontally at least.

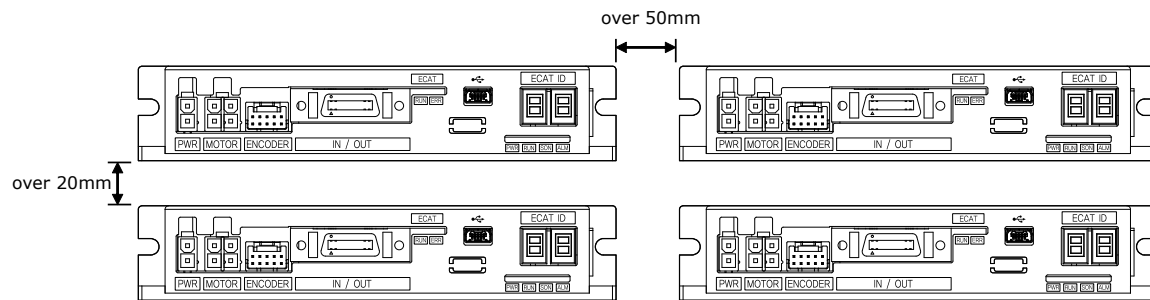

2.2 System Configuration

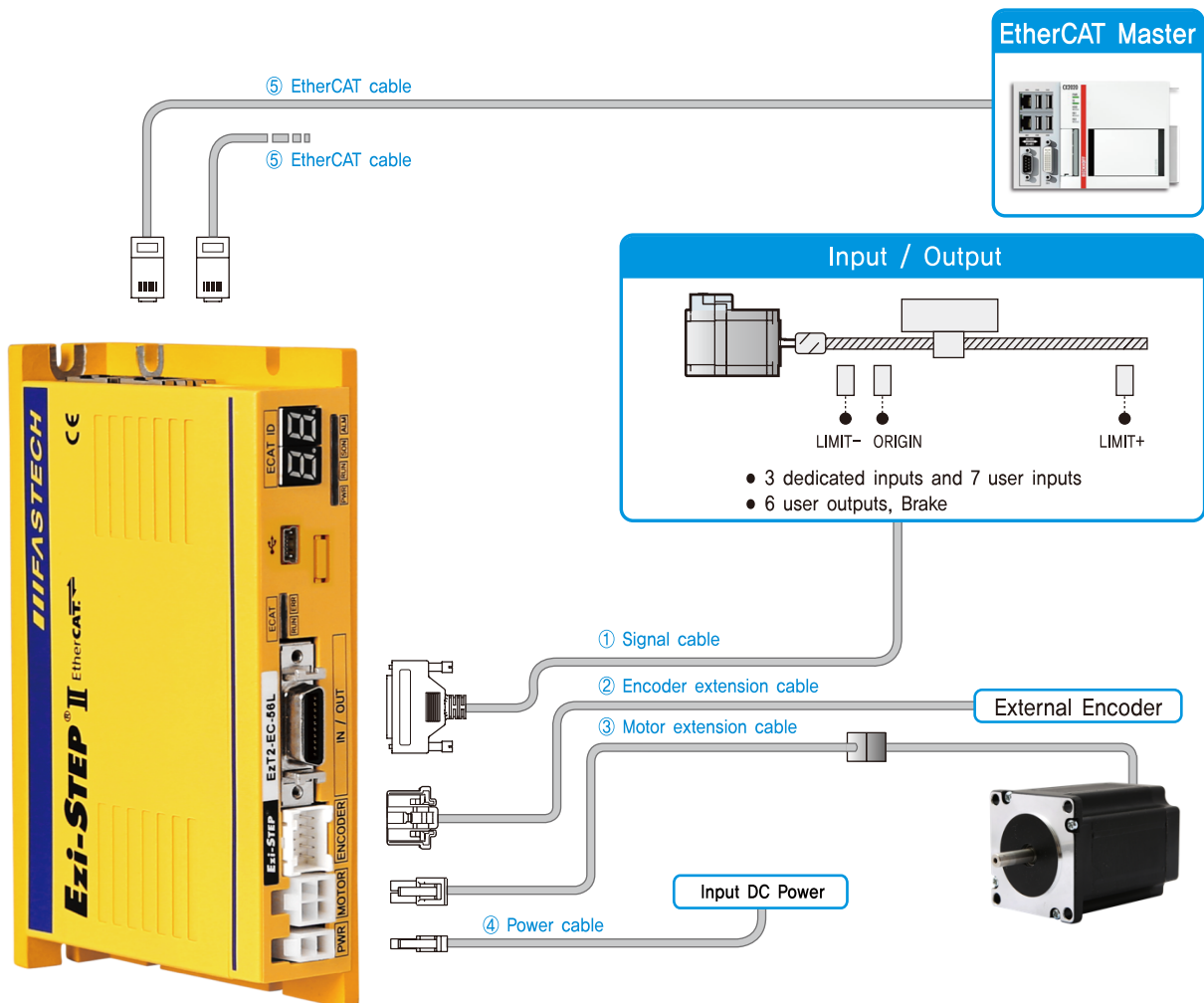

Figure 2.1: System Configuration Diagram of Ezi-STEP II EtherCAT

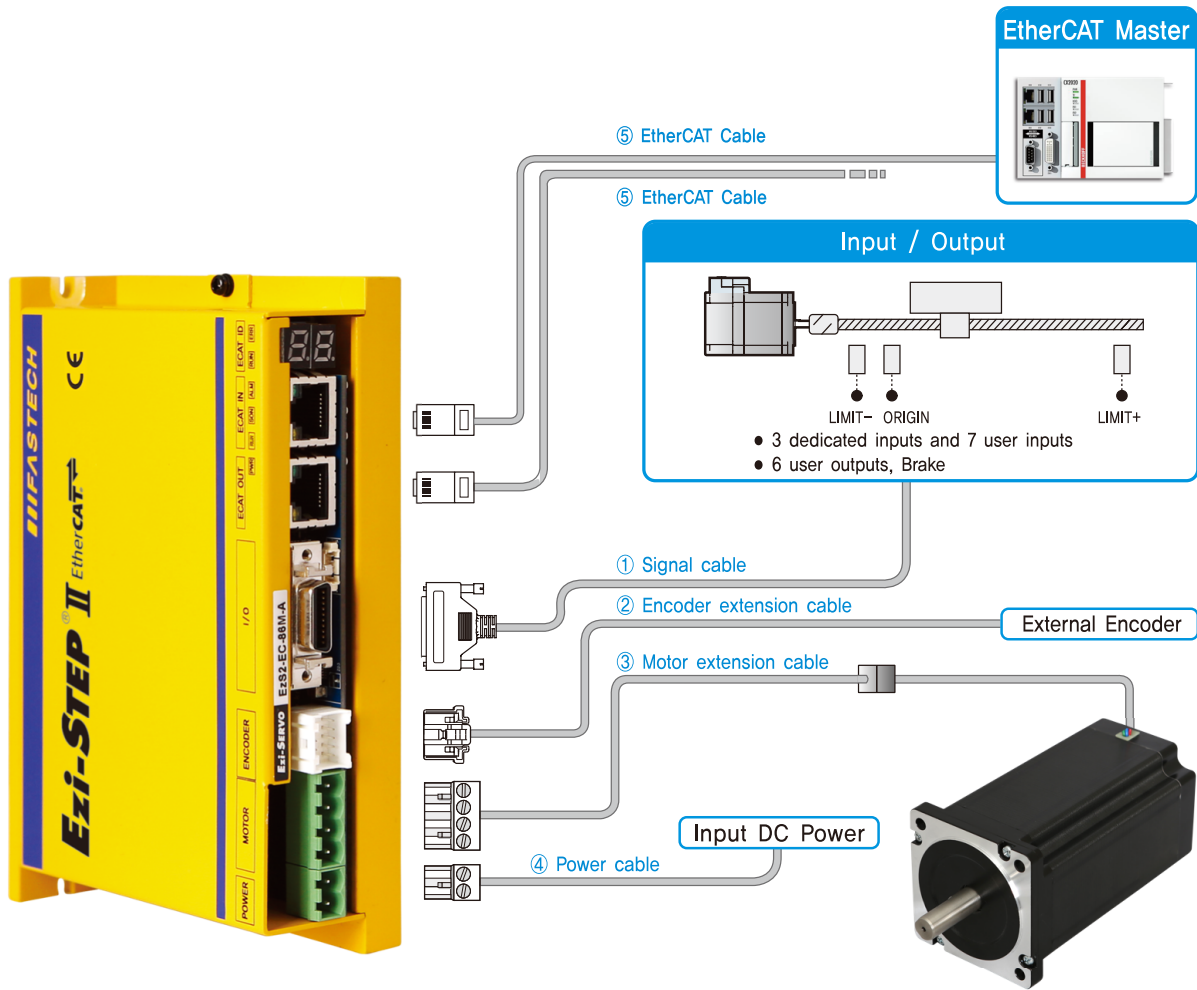

Figure 2.2: System Configuration Diagram of Ezi-STEP II EtherCAT 86

2.3 External Wiring Diagram

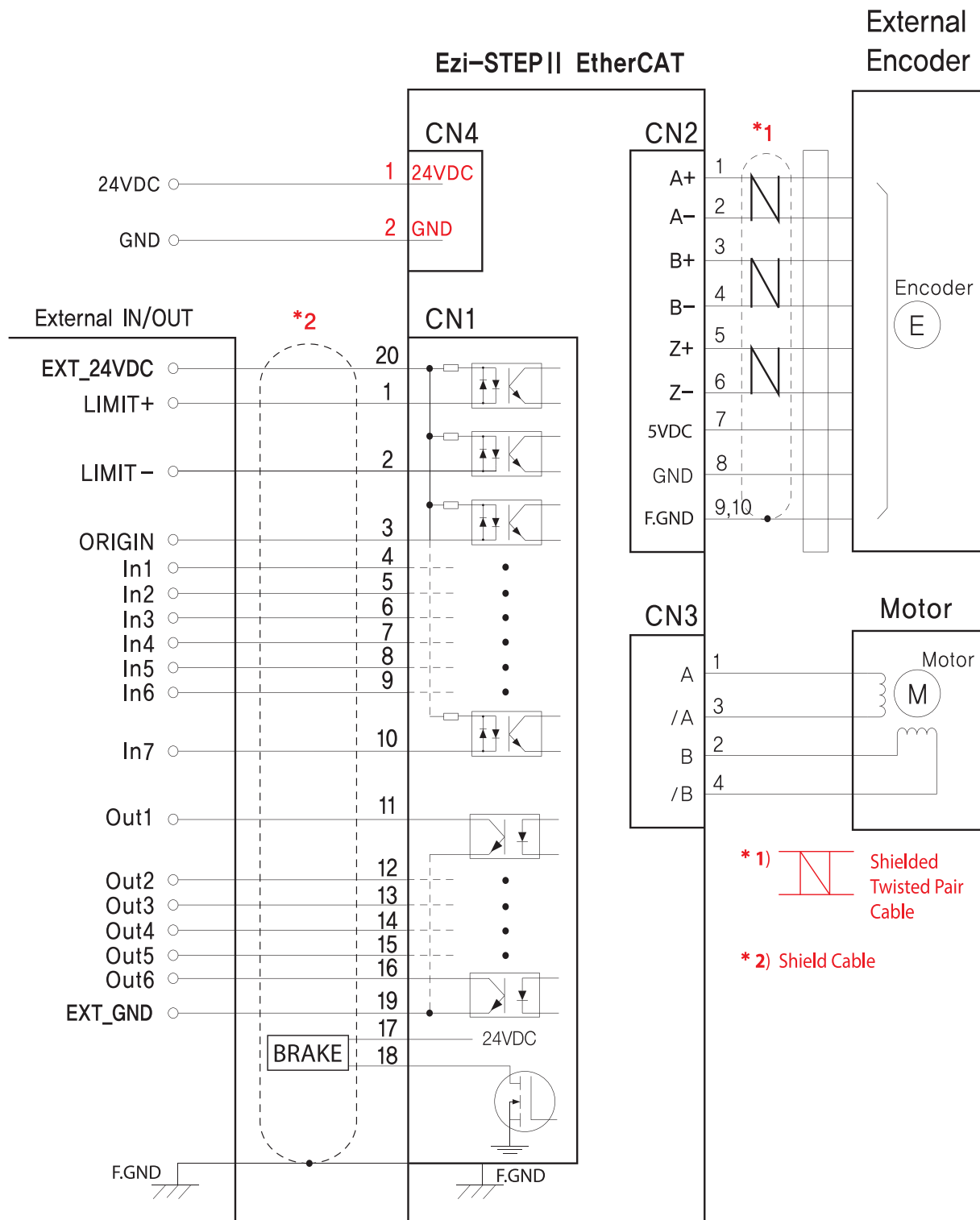

Figure 2.3: External Wiring Diagram of Ezi-STEP II EtherCAT

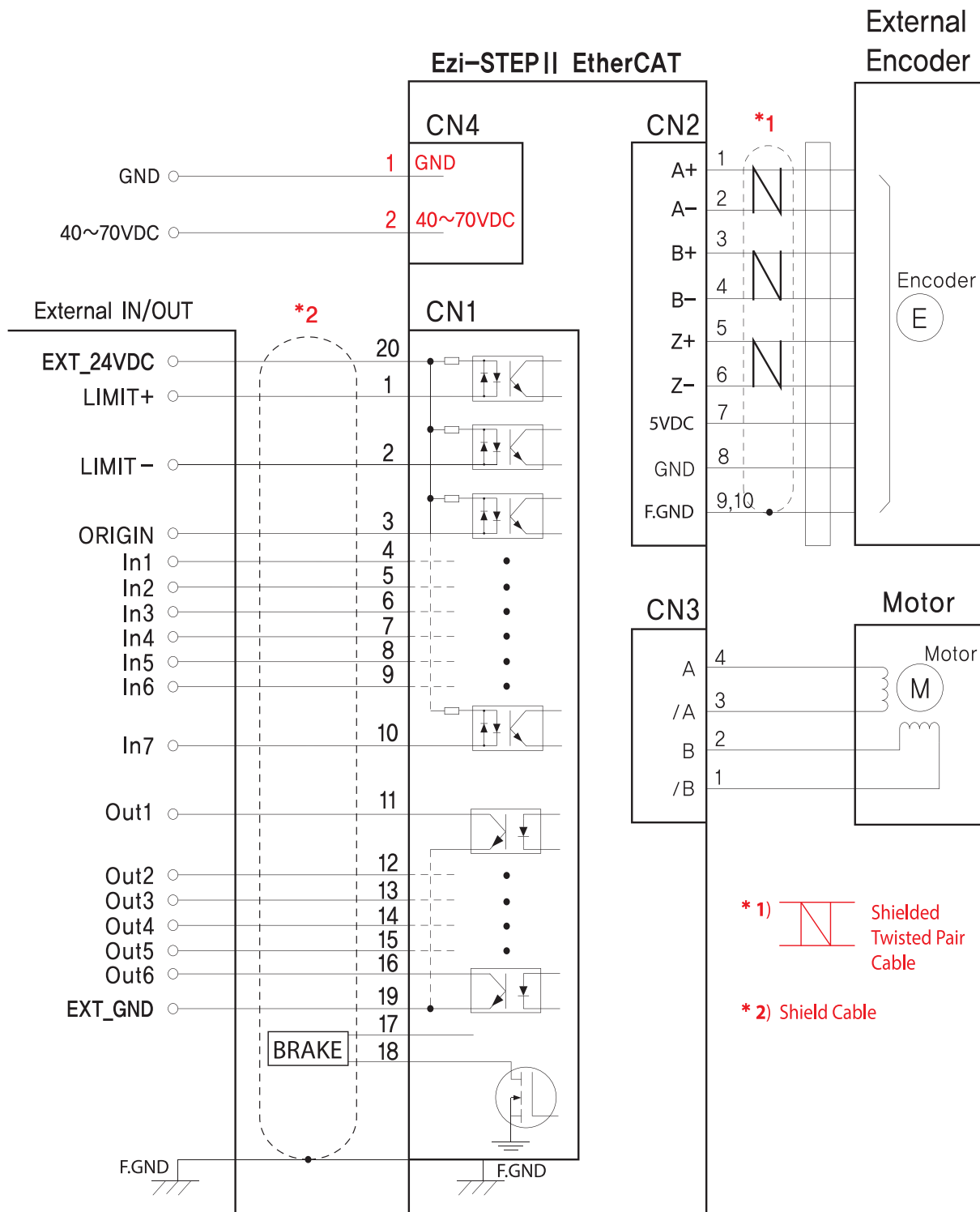

Figure 2.4: External Wiring Diagram of Ezi-STEP II EtherCAT 86

2.4 Appearance and Part Name

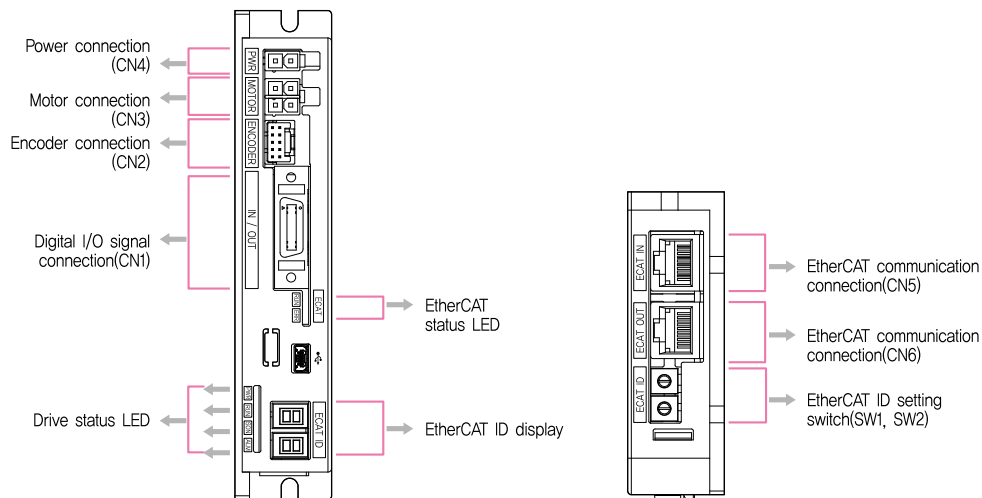

Figure 2.5: Appearance of Ezi-STEP II EtherCAT

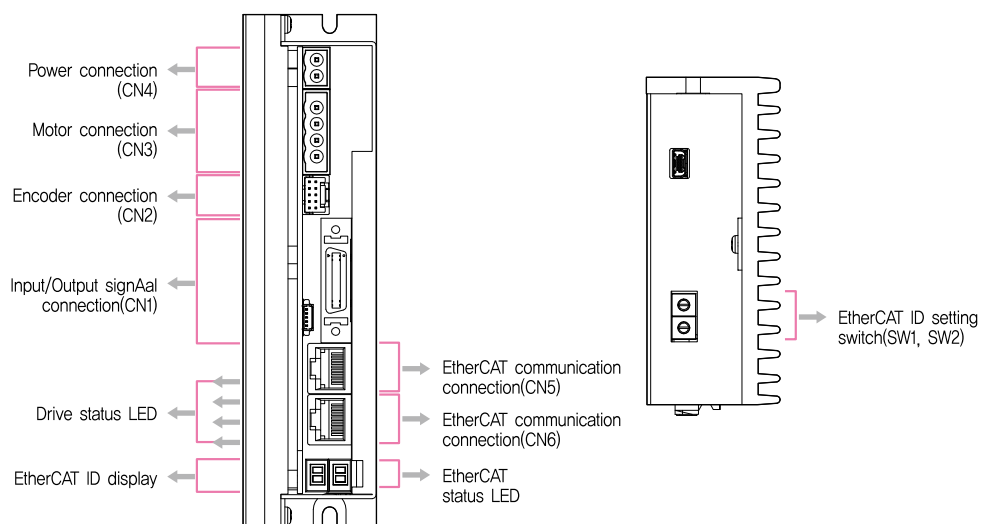

Figure 2.6: Appearance of Ezi-STEP II EtherCAT 86

2.4.1 EtherCAT ID

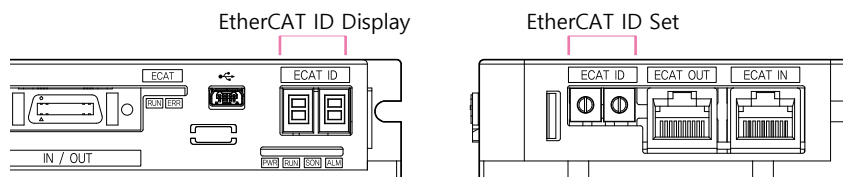

Figure 2.7: EtherCAT ID

ID Setting

Change EtherCAT ID (Configured Alias ID) value by Rotary switch setting. Right switch indicates tens and left switch indicates units.

Setting range is 0 ~ 99.

Information

ID value (Configured Alias ID) set by Rotary switch applies when power of controller turns on.



ID Indication

7-Segment indicates Physical Address or EtherCAT ID (EtherCAT configured Alias) value. Conditions for value indication as below.

- When Rotary Switch set all '0', 7-Segment indicates EtherCAT Physical Address Value. Before Physical Address assigned due to no connection between controller and master, It indicates 0. Once Master assigns each controllers physical address, it indicates relevant value.
- If Rotary switch set as not 0 but other value, 7-Segment indicates relevant set value (EtherCAT configured Alias).
- If 7-Segment of ID blinks, It indicates ID value as not applied yet. It can be applied once power turn on again.

Error value indication

If error generates from controller (Fault Status), 7-Segment indicates Error value instead of EtherCAT ID Value.

Error value is 'E-000' types then 2 digits will be indicated at 7-Segment.

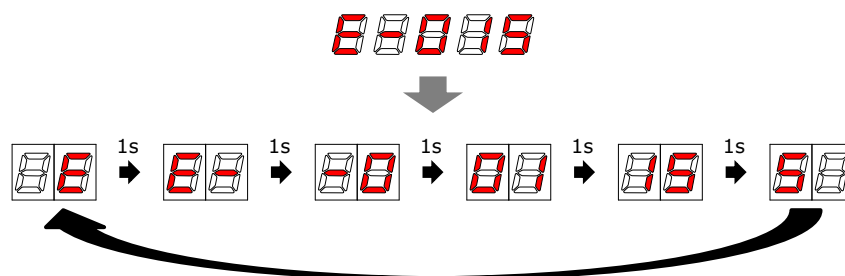

Figure 2.8: Error value indication (ex: E-015)

Please refer to [4.2 Error Code](#) regarding indication value

2.4.2 EtherCAT Status LED

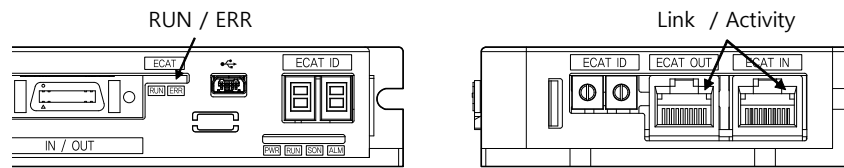

Figure 2.9: EtherCAT Status LED

This LED informs EtherCAT communication status. RUN LED, ERROR LED positions at the front side of product and, Link/Activity LED individually positions at the top of right corner of EtherCAT ports..

| Indication | Color | Status | Description |
|---------------|-------|--------------|--|
| RUN | Green | OFF | Init Status or Power OFF |
| | | Blinking | Pre-Operational Status |
| | | Single Flash | Safe-Operational Status |
| | | ON | Operational Status |
| | | Flickering | Bootstrap Status |
| ERR | Red | OFF | Non-error status or Power OFF |
| | | Blinking | Extra Error |
| | | Single Flash | Sync Error |
| | | Double Flash | Watch-dog Error |
| Link/Activity | Green | OFF | Link not established in physical layer |
| | | ON | Link established in physical layer |
| | | Flickering | In operation after establishing link |

Table 2.1: EtherCAT Status LED

Type of Status Indication

EtherCAT LED Status Indication shown as picture as below to check visually.

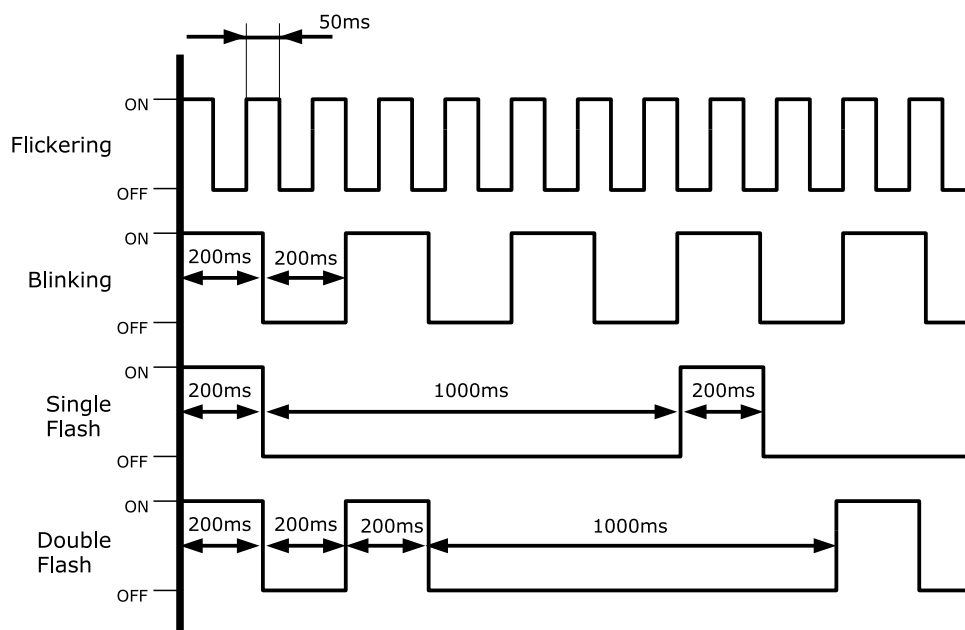

Figure 2.10: EtherCAT LED

2.4.3 EtherCAT Communication Connection

Connect communication cable from Master into communication connection ECAT IN. If there is next controller, connect communication cable from ECAT OUT to next controller of ECAT IN.

| No. | Function |
|-----------------|----------|
| 1 | TD+ |
| 2 | TD- |
| 3 | RD+ |
| 4 | - |
| 5 | - |
| 6 | RD- |
| 7 | - |
| 8 | - |
| Connection hood | F.GND |

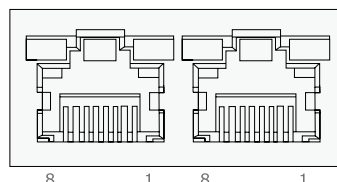

Table 2.2: EtherCAT Connector

EtherCAT Communication Cable

Recommend to use communication cable Min. CAT5e level above.

- CAT5e or above
- Shield type : SF/FTP, S/FTP, SF/UTP
- Length : Max. 50m (Distance between Nodes)

2.4.4 I/O Connector

Input and output signals of the drive are all photo-coupler protected, the signal status of internal photo-couplers [ON:conduction], [OFF:Non-conduction], not displaying the voltage levels of the signal.

| No. | Function | I/O |
|-----|--------------|--------|
| 1 | LIMIT+ | Input |
| 2 | LIMIT- | Input |
| 3 | ORIGIN | Input |
| 4 | Digital In1 | Input |
| 5 | Digital In2 | Input |
| 6 | Digital In3 | Input |
| 7 | Digital In4 | Input |
| 8 | Digital In5 | Input |
| 9 | Digital In6 | Input |
| 10 | Digital In7 | Input |
| 11 | Digital Out1 | Output |
| 12 | Digital Out2 | Output |
| 13 | Digital Out3 | Output |
| 14 | Digital Out4 | Output |
| 15 | Digital Out5 | Output |
| 16 | Digital Out6 | Output |
| 17 | BRAKE + | Output |
| 18 | BRAKE - | Output |
| 19 | EXT GND | Input |
| 20 | EXT 24VDC | Input |

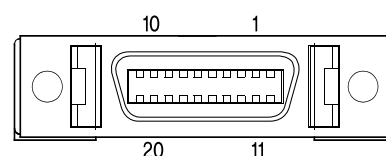

Table 2.3: I/O Connector

Limit and Origin input signal

Connect Limit sensor and origin sensor to IN/OUT Connector of LIMIT+, LIMIT-, ORIGIN Pin. LIMIT+ and LIMIT- sensor works to limit each axis of rotation range to CW and CCW direction, using for protection of mechanical collision or others. ORIGIN Sensor uses to assign origin of mechanisms.

Brake Signal Output Signal

Brake function prevents motor rotation under Servo OFF Status by BRAKE+ / BRAKE- pin of I/O Connector (2.3 I/O Connector). 'BRAKE+' is for +24V externally supplied to operate Brake circuit and 'BRAKE-' is output signal for actual motor control. Control signal automatically generates according to Servo ON/OFF status and Alarm generation. This output function can be only using under 600[mA]/DC24V of Brake current consumption.

Input Signal

Please individually prepare Power for Input circuit as DC 24V $\pm 10\%$ (Current consumption is around 5mA/Circuit)

Output Signal

Please individually prepare Power Supply for Output circuit. Possible to share with power supply for input circuit and in this case, please add capacity of power supply for output into capacity of power supply for input. Supply voltage and capacity of power for control output connection as below.

- Less than 30V of supply voltage
- Less than 15mA of current flow

2.4.5 Encoder Connection Connector

| No. | Function | I/O |
|-----|----------|--------|
| 1 | A+ | Input |
| 2 | A- | Input |
| 3 | B+ | Input |
| 4 | B- | Input |
| 5 | Z+ | Input |
| 6 | Z- | Input |
| 7 | 5VDC | Output |
| 8 | GND | Output |
| 9 | F.GND | - |
| 10 | F.GND | - |

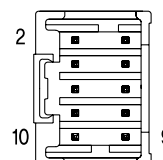

Table 2.4: Encoder Connection Connector

2.4.6 Motor Connection Connector

| No. | Function | I/O |
|-----|----------|--------|
| 1 | A Phase | Output |
| 2 | B Phase | Output |
| 3 | /A Phase | Output |
| 4 | /B Phase | Output |

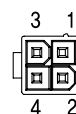

Table 2.5: Motor Connection Connector of Ezi-STEP II EtherCAT

| No. | Function | I/O |
|-----|----------|--------|
| 1 | A Phase | Output |
| 2 | B Phase | Output |
| 3 | /A Phase | Output |
| 4 | /B Phase | Output |

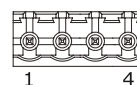

Table 2.6: Motor Connection Connector of Ezi-STEP II EtherCAT 86

2.4.7 Power Connection Connector

| No. | Function | I/O |
|-----|----------|-------|
| 1 | 24VDC | Input |
| 2 | GND | Input |



Table 2.7: Power Connection Connector of Ezi-STEP II EtherCAT

| No. | Function | I/O |
|-----|----------|-------|
| 1 | GND | Input |
| 2 | 40~70VDC | Input |



Table 2.8: Power Connection Connector of Ezi-STEP II EtherCAT 86

2.4.8 USB Connector

Connect to a PC using USB cable to the USB Connector. Monitoring status of drive and setting parameters are possible using a provided PC program (Network Setting Program).

| No. | Function |
|-----|-----------|
| 1 | V_{BUS} |
| 2 | D- |
| 3 | D+ |
| 4 | - |
| 5 | GND |

Table 2.9: USB Connector

Please use USB 2.0 Mini Type B connector.

Information

For more information on the PC program, please refer to the program manual.



2.5 Appendix

2.5.1 Extension Cable for Motor

For cable extension between Motor and Drive.



| Connector of Drive | | Wiring | Connector of Motor | |
|---|------------------|---|--------------------|---|
| Pin layout | Pin number | | Pin number | Pin layout |
|  | 1 2 3 4 |  | 1 2 3 4 |  |

Table 2.10: Wiring Diagram of Ezi-STEP II EtherCAT

| Connector of Drive | | Wiring | Connector of Motor | |
|---|------------------|---|--------------------|---|
| Pin layout | Pin number | | Pin number | Pin layout |
|  | 1 2 3 4 |  | 1 2 3 4 |  |

Table 2.11: Wiring Diagram of Ezi-STEP II EtherCAT 86

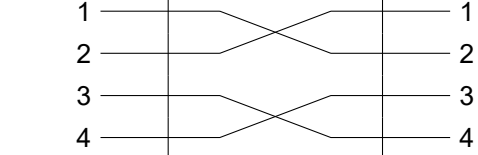
2.5.2 Extension Cable for Encoder

For cable extension between Encoder and Drive.

| Connector of Drive | | Wiring | Connector of Motor | |
|---|----------------|--------|--------------------|---|
| Pin layout | Pin number | | Pin number | Pin layout |
|  | 1 | — | 1 |  |
| | 2 | — | 2 | |
| | 3 | — | 3 | |
| | 4 | — | 4 | |
| | 5 | — | 5 | |
| | 6 | — | 6 | |
| | 7 | — | 7 | |
| | 8 | — | 8 | |
| | 9 ¹ | — | 9 ¹ | |
| | 10 | | | |

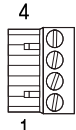
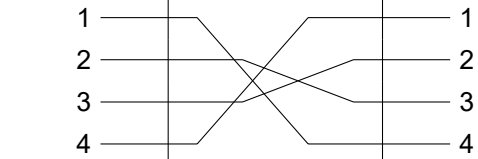
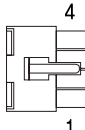
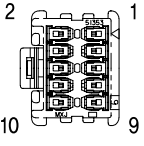
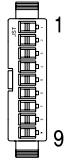
¹ Connect to Shield

Table 2.12: Wiring Diagram

2.5.3 Connector Specifications

The connector specifications used to connect the drive.

| Usage | | ITEM | Part Number | Maker |
|---------|------------|------------------------|--------------------------------|-------|
| Power | | Housing Terminal | 5557-02R 5556T | MOLEX |
| Motor | Drive side | Housing Terminal | 5557-04R 5556T | MOLEX |
| | Motor side | Housing Terminal | 5557-04R 5556T | MOLEX |
| Encoder | Drive side | Housing Terminal | 51353-1000 56134-9000 | MOLEX |
| | Motor side | Housing Terminal | SMP-09V-NC SHF-001T-0.8BS | JST |
| Signal | | Connector Backshell | 10120-3000VE 10320-52AO-008 | 3M |

Table 2.13: Connector specification of Ezi-STEP II EtherCAT

| Usage | | ITEM | Part Number | Maker |
|---------|------------|------------------------|--------------------------------|-------|
| Power | | Terminal Block | AK950-2 | PTR |
| Motor | Drive side | Terminal Block | AK950-4 | PTR |
| | Motor side | Housing Terminal | 3191-4RI 1381T | MOLEX |
| Encoder | Drive side | Housing Terminal | 51353-1000 56134-9000 | MOLEX |
| | Motor side | Housing Terminal | SMP-09V-NC SHF-001T-0.8BS | JST |
| Signal | | Connector Backshell | 10120-3000VE 10320-52AO-008 | 3M |

Table 2.14: Connector specification of Ezi-STEP II EtherCAT 86

- These connectors are serviced together with Ezi-STEP II EtherCAT except when purchasing option cables.
- Above connector is the most suitable product for Ezi-STEP II EtherCAT. Another equivalent connector can be used.

Chapter 3

EtherCAT Communication

3.1 CAN application protocol over EtherCAT

Ezi-STEP II EtherCAT is EtherCAT communication embedded type of controller to support CAN application protocol over EtherCAT (CoE). EtherCAT Slave structure is as below.

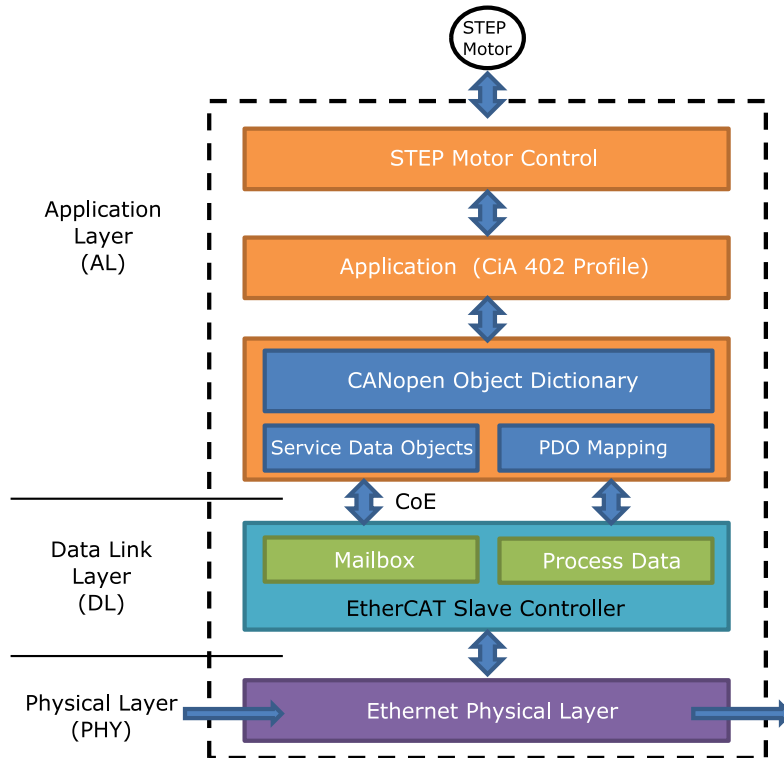

Figure 3.1: EtherCAT Structure

3.1.1 Object Dictionary

Object Dictionary is dictionary of Objects what product has.

3.1.2 Mailbox Communication

Master and Slave commands and receives Service Data Object (SDO) at Mailbox communication (SDO Communication). This communication method is the way of message transfer and master delivers command and slave responses.

SDO Communication used for setting or confirmation of objects at Object Dictionary. This communication can be used under Pre-Operational, Safe-Operational, Operational status of controller.

3.1.3 Process Data Communication

Process Data Communication (PDO Communication) commands and receives Process Data Objects (PDO) with Master periodically. Data that will be delivered and received is already defined at the initial stage of communication by PDO Mapping.

PDO communication is categorized as transmission PDO (following TxPDO) delivers controller status information and Receipt PDO (following RxPDO) delivers command from master.

This communication can be used under Operational status of controller and TxPDO is only available for Safe-Operational.

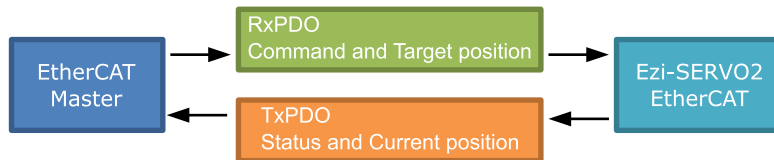

Figure 3.2: EtherCAT PDO Communication

3.2 PDO Mapping

PDO Mapping is to set Application Object will be delivered and received by PDO communication.

3.2.1 PDO Mapping

TxPDO Mapping information to be delivered to Master is to set at 1600h ~ 1601h Object and RxPDO Mapping information to be received command from master is to set at 1A00h ~ 1A01h Object.

Object ID value, Low level Index value, length of data (bit unit) of data that will be delivered and received are recorded at Mapping Table.

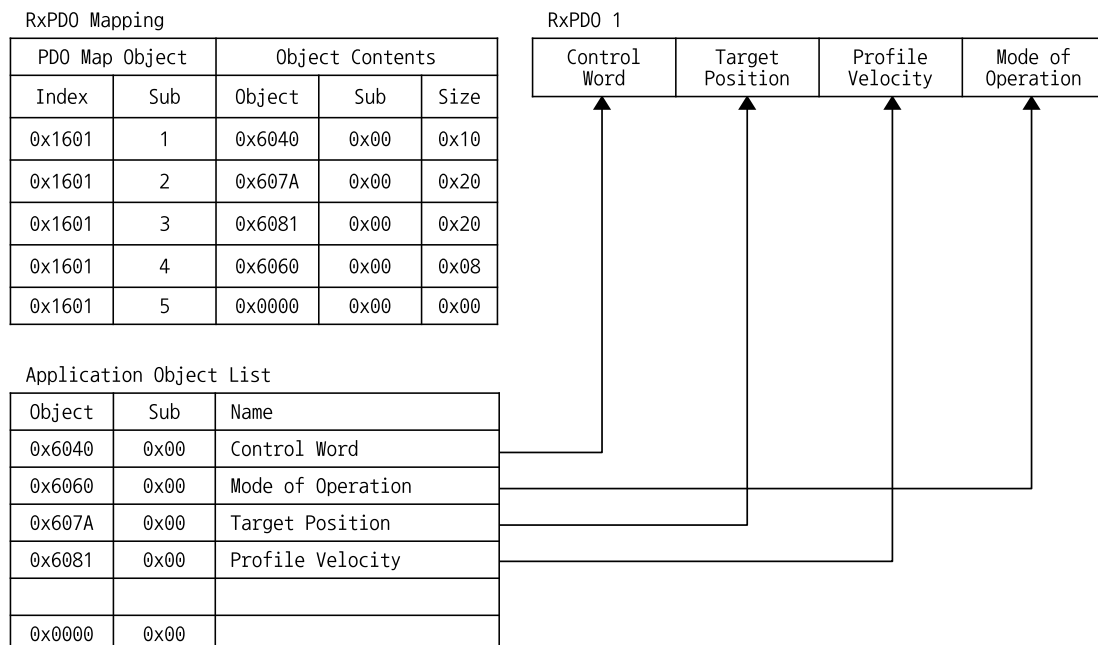

Figure 3.3: PDO Mapping

3.2.2 PDO Assign

PDO Assign is to set PDO Mapping Object will be assigned at SyncManager.

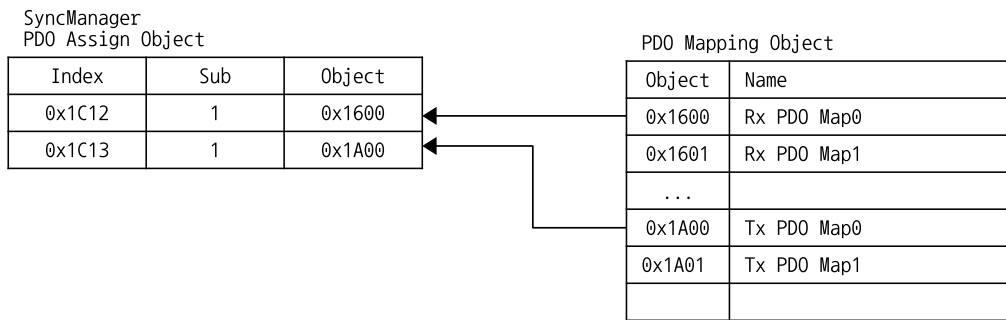

Figure 3.4: PDO Assign

1C12h is object to assign RxPDO and can assign one object among RxPDO Object 1600h or 1601h. 1C13h is object to assign TxPDO and can assign one object among TxPDO Object 1A00h or 1A01h.

3.3 EtherCAT State Machine

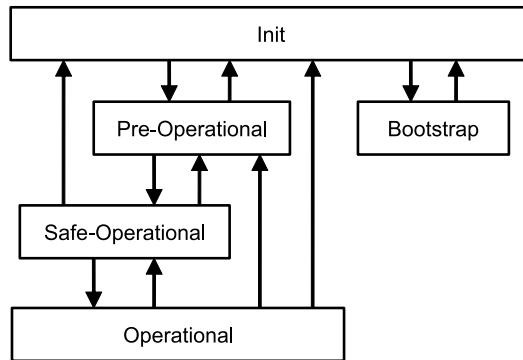

Figure 3.5: EtherCAT State Machine

EtherCAT controller of status motion is controlled by EtherCAT Master.

| Status | SDO | RxPDO | TxPDO | Description |
|------------------|---------------|---------------|---------------|---|
| Init | Non Available | Non Available | Non Available | EtherCAT communication is to reset. Status of communication is not available at this stage. |
| Pre-Operational | Available | Non Available | Non Available | After initialization of communication, enters into this stage. Network setting is initialized. Only mailbox communication is available at this stage. |
| Safe-Operational | Available | Non Available | Available | Stage of TxPDO communication is available. |
| Operational | Available | Available | Available | All of communication is available. |
| Bootstrap | Available | Non Available | Non Available | Only mailbox communication is available. Possible to renew F/W of product with using FoE Protocol at this stage. |

Table 3.1: EtherCAT Operational State

3.4 Synchronization

Synchronization modes provided from controller are as below.

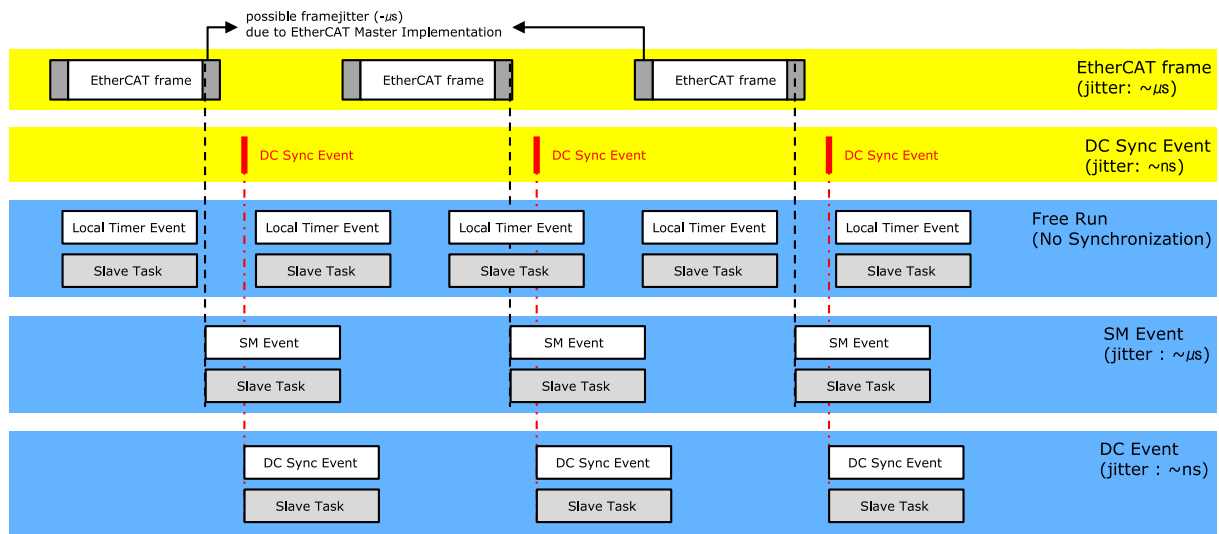

Figure 3.6: Type of EtherCAT Synchronization and Differences

3.4.1 Free Run

Controller runs under non-synchronization with Master. Under Free Run mode, Master and Controller has an individual independent Cycle.

3.4.2 SM Event

Controller runs under synchronization with SM Event of EtherCAT communication. SM Event is generated once controller receives EtherCAT Frame.

Once synchronization by SM Event, each one of controller has few us range of jitter.

3.4.3 DC Sync Event

Synchronized controller runs under Sync Interrupt is generated according to Distributed Clock (following DC).

DC is synchronized time shared between Master and Slave. With synchronized clock, interrupt is generated under accurate synchronization and controller executes commands under accurate timing.

In this case, each one of controller has few us range of jitter.

3.5 EtherCAT Slave Information

EtherCAT Slave Information file (XML File) is needed to connect controller with EtherCAT Master. This file is described slave device information as XML format based on EtherCAT specifications. With recording of XML file into EtherCAT Master Equipment through EtherCAT setting equipment, easily implement PDO and SDO setting of Slave device.

Information

XML file can be downloaded from product website of archives.



Chapter 4

CiA402 Drive Profile

4.1 Drive Status Control

Status of product moves as follows. Status movement is executed by status of controller and Control word (6040h) and current status can be checked by Status word (6041h).

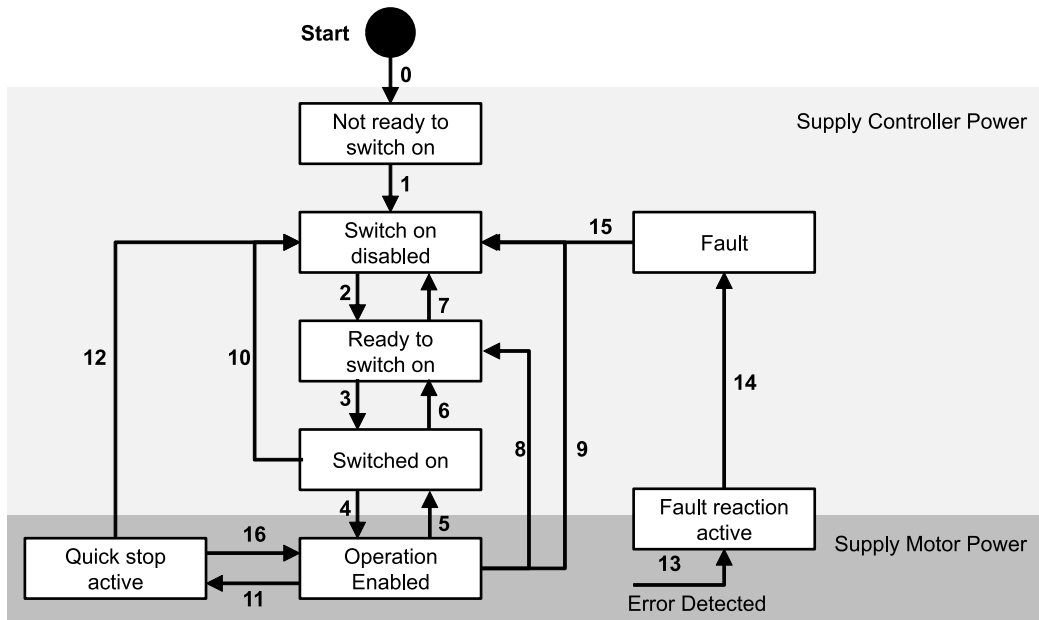

Figure 4.1: Drive State Machine

Status movement and meaning of each status is as follows.

| Transition | Event | Action |
|------------|--|--|
| 0 | Automatic transition after power-on or reset application | Drive self-test and/or self initialization shall be performed. |
| 1 | Automatic transition | Communication shall be activated |
| 2 | Automatic transition ¹ or Shutdown command from control device | |
| 3 | Switch On command from control device | |
| 4 | Enable Operation command from control device | The drive function shall be enabled. |
| 5 | Disable Operation command from control device | The drive function shall be disabled, Motor power shall be switched off. |
| 6 | Shutdown command from control device | |
| 7 | Quick Stop or Disable Voltage command from control device | |
| 8 | Shutdown command from control device | The drive function shall be disabled, Motor power shall be switched off. |
| 9 | Disable Voltage command from control device | The drive function shall be disabled, Motor power shall be switched off. |
| 10 | Quick Stop or Disable Voltage command from control device | |
| 11 | Quick Stop command from control device | The quick stop function shall be started. |
| 12 | Automatic transition (depends on the Quick stop option code) | The drive function shall be disabled, Motor power shall be switched off. |
| 13 | Fault signal | the configured fault reaction function shall be executed. |
| 14 | Automatic transition | The drive function shall be disabled, Motor power shall be switched off. |
| 15 | Fault Reset command from control device | A reset of the fault condition is carried out. |
| 16 | Enable Operation command from control device (depends on the Quick stop option code) | The drive function shall be enabled. |

¹ This transition is configurable. Please refer to Object 2030h: Advanced settings Sub-Index 2 - Disable Automatic transition 2.

Table 4.1: State transition

Each status of functions supported by controller as follows.

| Status | Brake Function | Motor Power | Control Command |
|------------------------|----------------|-------------|-----------------|
| Not ready to switch on | Yes | No | No |
| Switch on disabled | Yes | No | No |
| Ready to switch on | Yes | No | No |
| Switched on | Yes | No | No |
| Operation enabled | Yes | Yes | Yes |
| Quick stop active | Yes | Yes | Yes |
| Fault reaction active | Yes | Yes | Yes |
| Fault | Yes | No | No |

Table 4.2: Function per Status

4.1.1 Control word

| | | | | | | | |
|--------------|--------|------------------|--------|------------------|------------|----------------|-----------|
| Bit 15 | Bit 14 | Bit 13 | Bit 12 | Bit 11 | Bit 10 | Bit 9 | Bit 8 |
| - | - | oms ² | | - | - | - | Halt |
| Bit 7 | Bit 6 | Bit 5 | Bit 4 | Bit 3 | Bit 2 | Bit 1 | Bit 0 |
| Fault Re-set | oms | | | Enable Operation | Quick Stop | Enable Voltage | Switch On |

Table 4.3: Control word

Able to control the status of controller by 0 ~ 3, 7 bits of Control word and bits per target status are as follows.

| Command | Bit of Control word | | | | | Transition |
|------------------------------|---------------------|-------|-------|-------|-------|--------------|
| | Bit 7 | Bit 3 | Bit 2 | Bit 1 | Bit 0 | |
| Shutdown | 0 | x | 1 | 1 | 0 | 2, 6, 8 |
| Switch on | 0 | 0 | 1 | 1 | 1 | 3 |
| Switch on + Enable operation | 0 | 1 | 1 | 1 | 1 | 3 + 4 |
| Disable voltage | 0 | x | x | 0 | x | 7, 9, 10, 12 |
| Quick stop | 0 | x | 0 | 1 | x | 7, 10, 11 |
| Disable Operation | 0 | 0 | 1 | 1 | 1 | 5 |
| Enable Operation | 0 | 1 | 1 | 1 | 1 | 4, 16 |
| Fault reset | 0 → 1 | x | x | x | x | 15 |

Table 4.4: Set Control word for status movement

If Quick stop option code (605Ah) of value is 5, 6, 7, 8 under Quick stop active status, waiting at correspondent status. Able to move to Operation Enabled status by 'Enable Operation' command of Control word.

Other bits are as follows.

| Bit | Value | Description |
|-----|-------|---|
| 8 | 0 | The motion is executed or continued. |
| | 1 | Stop motor according to Halt option code (605Dh). |

Table 4.5: Bit description of Control word

4.1.2 Status word

| | | | | | | | |
|-------------------------------|--------------------|------------|-----------------|-----------------------|-------------------|-------------|--------------------|
| Bit 15 | Bit 14 | Bit 13 | Bit 12 | Bit 11 | Bit 10 | Bit 9 | Bit 8 |
| Safety Activated ³ | oms | | | Internal Limit Active | oms | Remote | oms |
| Bit 7 | Bit 6 | Bit 5 | Bit 4 | Bit 3 | Bit 2 | Bit 1 | Bit 0 |
| - | Switch on disabled | Quick stop | Voltage enabled | Fault | Operation enabled | Switched on | Ready to switch on |

Table 4.6: Status word

²oms : it's an abbreviation for Operation mode specific. Functions vary depending on the Operation Mode. Please refer to the Control word description for each Operation Mode.

Status word of values per each status are as follows.

The current drive state (Drive State Machine) can be checked through the state of some bits.

| Status word | Status |
|----------------------|------------------------|
| xxxx xxxx x0xx 0000b | Not ready to switch on |
| xxxx xxxx x1xx 0000b | Switch on disabled |
| xxxx xxxx x01x 0001b | Ready to switch on |
| xxxx xxxx x011 0011b | Switched on |
| xxxx xxxx x011 0111b | Operation enabled |
| xxxx xxxx x00x 0111b | Quick stop active |
| xxxx xxxx x0xx 1111b | Fault reaction active |
| xxxx xxxx x0xx 1000b | Fault |

Table 4.7: Current status following by Status word

Other bits are as follows.

| Bit | Value | Description |
|-----|-------|---|
| 9 | 1 | Control word processed normally. |
| 11 | 1 | Software Limit was detected. |
| 15 | 1 | The Safety function was activated and stopped. Please refer to 4.9 Safety Function for Safety function. |

Table 4.8: Bit description of Status word

³Safety Activated is a function on Ezi-STEP II EtherCAT that is not specified in CiA402 Drive Profile.

4.2 Error Code

Once Error generates at Controller (Sense Fault signal), changed to 'Fault reaction active' status. Under 'Fault' / 'Fault reaction active' status, types of error can be checked by Error code (603Fh).

| Error code Hex / Dec | External Indication ¹ | Status | Description |
|-------------------------|-------------------------------------|--|--|
| 7500h / 29952 | E-500 | EtherCAT Communication Error | An error occurred in EtherCAT Communication. |
| FF01h / 65281 | E-001 | Over Current Error | The current through power devices in inverter exceeds 4.8A. |
| FF02h / 65282 | E-002 | Over Speed Error | Motor speed exceed 3,000 [rpm]. |
| FF05h / 65285 | E-005 | Over Temperature Error | Inside temperature of drive exceeds 85°C. |
| FF06h / 65286 | E-006 | Over Regenerated Voltage Error | Motor Back-EMF is higher than limit value. ² |
| FF07h / 65287 | E-007 | Motor Connection Error | Abnormal connection between drive and motor. |
| FF0Ch / 65292 | E-012 | ROM Error | Error occurs in parameter storage device. (ROM) |
| FF31h / 65329 | E-049 | Drive Alarm | Generated Extra alarms generated from drive. |
| FF32h / 65330 | E-050 | Internal communication error of drive | Communication error from internal components of drive generated. (Time-out) |
| FF34h / 65332 | E-052 | Internal communication error of drive | Communication error from internal components of drive generated. (CRC Failed) |
| FF35h / 65333 | E-053 | Internal communication error of drive | Communication error from internal components of drive generated. (Command Failed) |
| FF3Ch / 65340 | E-060 | Torque enable Failure | The SVON signal of drive was not on during the Torque Enable process. |
| FF3Eh / 65342 | E-062 | TQOFF Input Error | Torque Enable command was called while the Safety function was active. |
| FF3Fh / 65343 | E-063 | Drive SVOFF Detect | Drive is torque disabled by itself. |
| FF42h / 65346 | E-066 | Torque disable Failure | The SVON signal of drive was not off during the Torque Enable process. |
| FF44h / 65348 | E-068 | Over Speed in CSP | In CSP mode, the commanded speed value exceeds the speed limit and cannot be followed. |
| FF45h / 65349 | E-069 | Safety Activated | The safety function is activated and drive is Torque Disabled. |
| FF47h / 65351 | E-071 | Network Initialization Error | An error occurred while initializing the hardware of EtherCAT communication. |
| FF49h / 65353 | E-073 | Synchronization Type Error | CSP mode was used in the wrong EtherCAT synchronization type. CSP mode is available when EtherCAT synchronization type is DC Sync Event. |
| FF4Bh / 65355 | E-075 | Abnormal Safety Input State ³ | The Digital Inputs allocated to TQOFF Input are different from each other. |
| FF4Ch / 65356 | E-076 | Internal communication failure of drive | Failure to start Communication of internal components of drive. |
| FF64h / 65380 | E-100 | ROM Initialization Error | ROM is blank status. |
| FF65h / 65381 | E-101 | ROM Initialization Error | Check sum of ROM is not matched. |
| FF66h / 65382 | E-102 | FRAM Access Error | Error generated during FRAM accessing. |
| FF6Eh / 65390 | E-110 | ROM Reading Error | Error generated during ROM reading. |
| FF79h / 65401 | E-121 | ROM Writing Error | Error generated during ROM writing. |
| FF7Ah / 65402 | E-122 | ROM Writing Error | Error generated during ROM writing. |
| FF7Bh / 65403 | E-123 | ROM Writing Error | Error generated during ROM writing. |
| FF7Ch / 65404 | E-124 | ROM Writing Error | Error generated during ROM writing. |
| FFC8h / 65480 | E-200 | ROM Data Out of Range Error | Some parameter values stored in ROM are out of range. |

¹Products that have a 7-segment on the front of the product will display Error code information in the two 7-segments instead of EtherCAT ID when the alarm occurs.

²Voltage limit of Back-EMF depends on motor model. Please refer to [4.10 Voltage Limit of Back-EMF](#).

³The 'Abnormal Safety Input State' alarm can be clear by recycling the power of the controller. It can not clear by 'Fault Reset' command of Control word.

The voltage limit of Back-EMF according to the motor model of the product are as follows.

| Motor Model | Voltage Limit | Motor Model | Voltage Limit | Motor Model | Voltage Limit |
|-------------|---------------|-------------|---------------|-------------|---------------|
| EzT2-20M | 48V | EzT2-42S | 70V | EzT2-60S | 70V |
| EzT2-20L | | EzT2-42M | | EzT2-60M | |
| EzT2-28S | | EzT2-42L | | EzT2-60L | |
| EzT2-28M | | EzT2-42XL | | EzT2-86M | 90V |
| EzT2-28L | | EzT2-56S | | EzT2-86L | |
| EzT2-35M | | EzT2-56M | | EzT2-86XL | |
| EzT2-35L | | EzT2-56L | | | |

Table 4.10: Voltage Limit of Back-EMF

4.3 Mode of operation

Currently activated Mode of operation display (6061h) decides the action of controller. Meaning for some bits of Control word (6040h) and Status word (6041h) Objects can be decided by Mode of operation display (6061h).

Able to set selected operation mode by Mode of operation (6060h). Currently activated operation mode can be checked by Mode of operation display (6061h).

Operation modes supported by current controller are as follows.

| Mode of operation | Description | Abbreviation |
|-------------------|----------------------------------|--------------|
| 1 | Profile Position Mode | PP |
| 6 | Homing Mode | HM |
| 8 | Cyclic Synchronous Position Mode | CSP |

Table 4.11: Supported Operation Modes

4.4 Cyclic Synchronous Position Mode

4.4.1 Definition

Cyclic Synchronous Position Mode(CSP Mode) assigns target position to controller by Master's operation profile creation function through cyclic communication. Controller internally executes position / velocity control with receipt of target position in each cycle.

To use CSP Mode, Mode of operation (6060h) Cyclic Synchronous Position Mode needs to be set. Mode of operation display (6061h) is shown as Cyclic Synchronous Position Mode, Target position transmitted from master : Object 607Ah: Target position is executed.

4.4.2 Related Objects

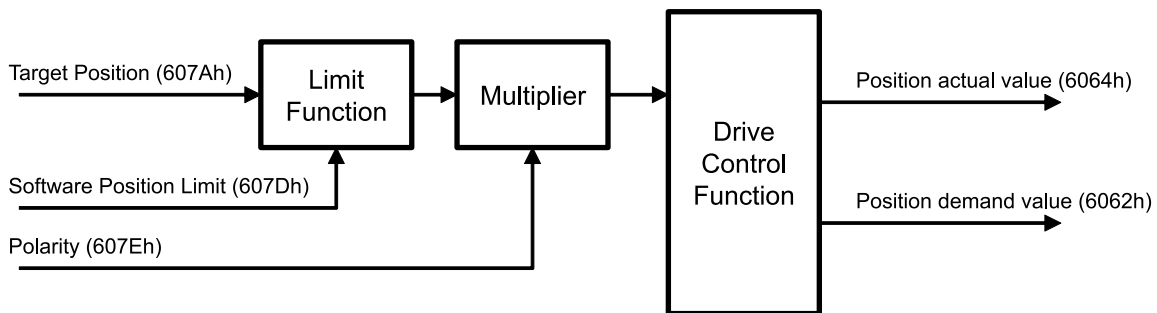

Figure 4.2: CSP Mode Objects

4.4.3 Control word and Status word

Control word

Control word under CSP Mode are as follows.

| Bit 15 | Bit 14 | Bit 13 | Bit 12 | Bit 11 | Bit 10 | Bit 9 | Bit 8 |
|-------------|--------|--------|--------|------------------|------------|----------------|-----------|
| - | - | - | - | - | - | - | Halt |
| Bit 7 | Bit 6 | Bit 5 | Bit 4 | Bit 3 | Bit 2 | Bit 1 | Bit 0 |
| Fault Reset | - | - | - | Enable Operation | Quick Stop | Enable Voltage | Switch On |

Table 4.12: Control word under CSP Mode

Please refer to [4.4 Set Control word for status movement](#) for the rest of bits.

Status word

Status word (6041h) under CSP Mode are as follows.

| Bit 15 | Bit 14 | Bit 13 | Bit 12 | Bit 11 | Bit 10 | Bit 9 | Bit 8 |
|------------------|--------------------|-----------------|-------------------------|-----------------------|-------------------|-------------|--------------------|
| Safety Activated | - | Following Error | Target position ignored | Internal Limit Active | - | Remote | - |
| Bit 7 | Bit 6 | Bit 5 | Bit 4 | Bit 3 | Bit 2 | Bit 1 | Bit 0 |
| - | Switch on disabled | Quick stop | Voltage enabled | Fault | Operation enabled | Switched on | Ready to switch on |

Table 4.13: Status word under CSP Mode

Please refer to drive status control for the rest of bits.

| Bit | Value | Description |
|-----|-------|---------------------------------|
| 12 | 0 | Target position value ignored. |
| | 1 | Target position value executed. |
| 13 | 1 | Following Error has occurred. |

Table 4.14: Bit description of Status word under CSP Mode

For other bits, please refer to [4.6 Status word](#).

4.5 Profile Position Mode

4.5.1 Definition

Profile Position Mode is to move to target position of Target position (607Ah) object with receipt of Control word (6040h) input.

It is general Point to point operation. To use Profile Position Mode, need to set Profile Position Mode at Mode of operation (6060h).

Mode of operation display (6061h) is shown as Profile Position Mode, ready to use position control command.

4.5.2 Related Objects

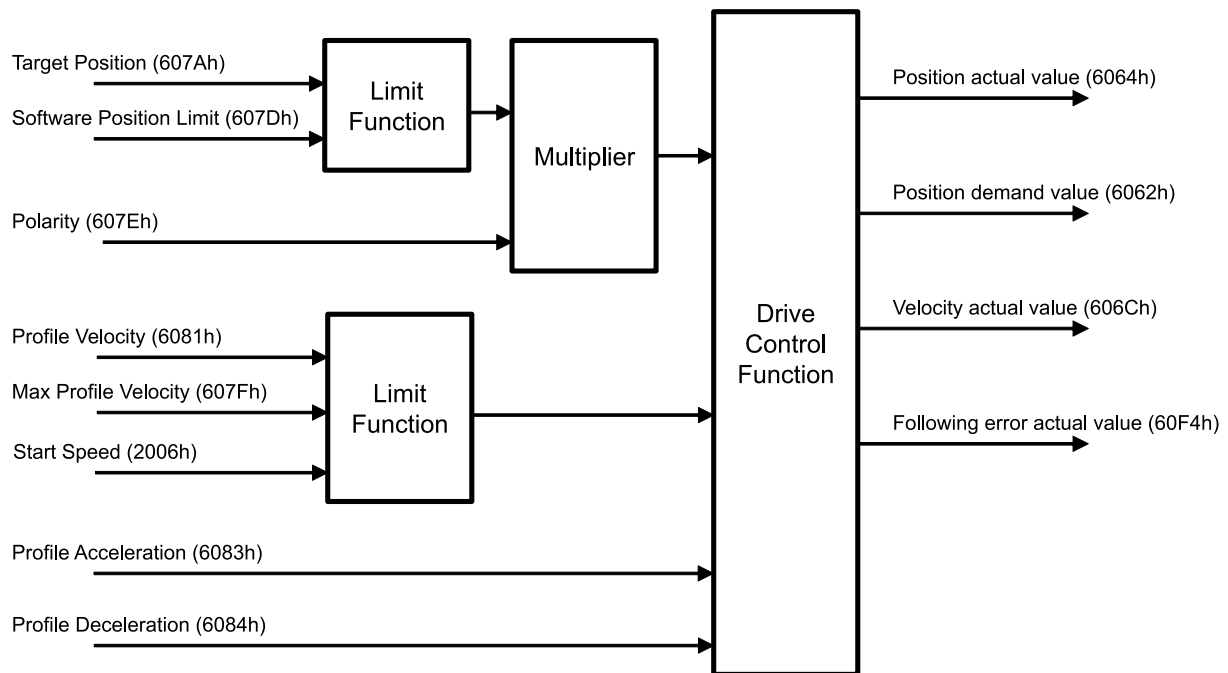

Figure 4.3: Profile Position Mode

4.5.3 Control word and Status word

Control word

Control word under Profile Position Mode are as follows.

| Bit 15 | Bit 14 | Bit 13 | Bit 12 | Bit 11 | Bit 10 | Bit 9 | Bit 8 |
|-------------|-----------------|-------------------------------|----------------------|------------------|------------|----------------|-------------|
| - | - | - | - | - | - | - | Halt |
| Bit 7 | Bit 6 | Bit 5 | Bit 4 | Bit 3 | Bit 2 | Bit 1 | Bit 0 |
| Fault Reset | Relative | Change Set Immediately | New Set-Point | Enable Operation | Quick Stop | Enable Voltage | Switch On |

Table 4.15: Control word under Profile Position Mode

Please refer to [4.4 Set Control word for status movement](#) for the rest of bits.

| Bit | Value | Description |
|-----|-------|---|
| 4 | 0 → 1 | Execute the motion command to a new location. The motion command method is determined by the values of bit 5. |
| 5 | 0 | If the motor is moving when the new motion command is executed, the new motion command is executed after the previous command is completed. |
| | 1 | If the motor is moving when the new motion command is executed, it ignored the previous command and moves to the new position immediately. |
| 6 | 0 | The value of Target position (607Ah) is destination position. (absolute position) |
| | 1 | The value of Target position (607Ah) is distance. (relative position) |
| 8 | 1 | Cancels the motion command and stops it according to the value of Halt option code (605Dh). |

Table 4.16: Bit description of Control word under Profile Position Mode

For other bits, please refer to [4.3 Control word](#).

Status word

Status word (6041h) under Profile Position Mode are as follows.

| Bit 15 | Bit 14 | Bit 13 | Bit 12 | Bit 11 | Bit 10 | Bit 9 | Bit 8 |
|------------------|--------------------|------------------------|------------------------------|-----------------------|-----------------------|-------------|--------------------|
| Safety Activated | - | Following Error | Set-Point Acknowledge | Internal Limit Active | Target Reached | Remote | - |
| Bit 7 | Bit 6 | Bit 5 | Bit 4 | Bit 3 | Bit 2 | Bit 1 | Bit 0 |
| - | Switch on disabled | Quick stop | Voltage enabled | Fault | Operation enabled | Switched on | Ready to switch on |

Table 4.17: Status word under Profile Position Mode

The functions of bits added in Profile Position Mode are as follows.

| Bit | Value | Description |
|-----|-------|--|
| 10 | 0 | The motor is moving through a motion command. |
| | 1 | The motor has stopped. |
| 12 | 0 | Control Word of New Set-Point(Bit 4) has reset and previous position movement command processed. Able to input new position. |
| | 1 | Control word of New Set-Point(Bit 4) is already set or previous position movement command is under processing. |
| 13 | 1 | Following Error generated. |

Table 4.18: Bit description of Status word under Homing Mode

Please refer to drive status control for the rest of bits.

4.5.4 Position movement method

General Movement

Movement command to new target position can be requested by changing Control word (6040h) of New Set-Point (Bit 4) from RESET to SET. Once controller receives this request, Set-Point Acknowledge of Status word (Bit 12) is going to be SET and position movement command executed. Target position refers to Target position (607Ah) and Position value can be absolute coordinates or relative coordinates by Control word of Relative (Bit 6).

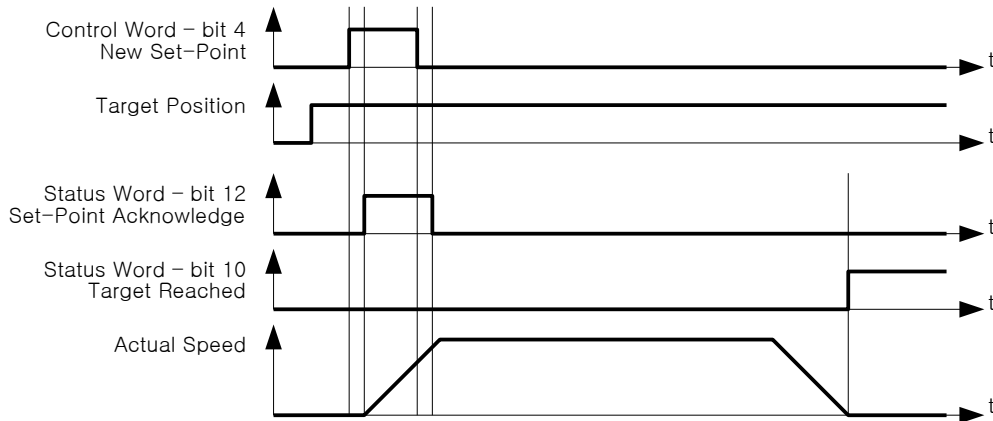

Figure 4.4: New Set-Point

Once reaches at target position, Status word of Target Reached (Bit 10) goes to SET. If it does not reach at target position due to error or status as below, Target Reached (Bit 10) can not be changed as SET.

- Fault status due to Error generation.
- Out of Operation Enabled Status.

Input next target position

Once commands to move to new target position during previous position movement still operates, executes new target position movement command after completion of previous position movement. So if already inputs next target position at buffer, position movement command can be executed immediately without time delay.

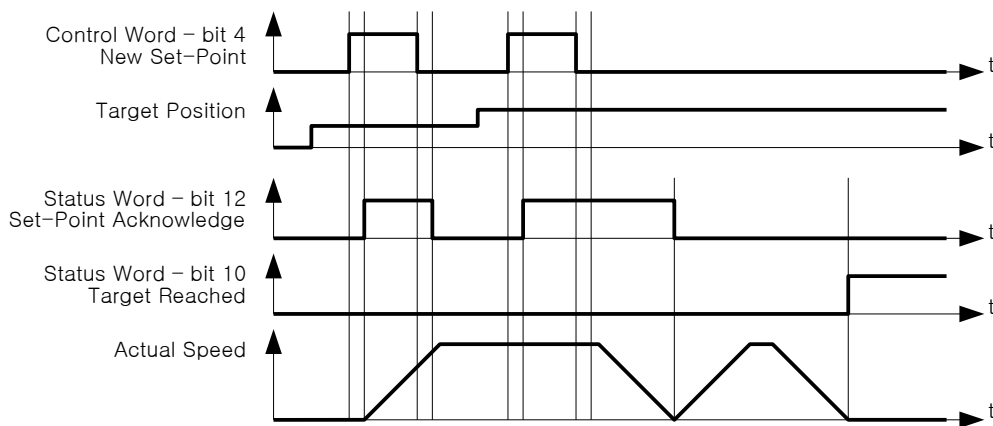

Figure 4.5: Next Set-Point

At this time, Status word of Set-Point Acknowledge (Bit 12) is going to be RESET of Control word of New Set-Point (Bit 4) and it goes to RESET after completion of previous position movement command. Target Reached (Bit 10) goes to SET once all of position movements completed.

Target position override

In case of using Control word of Change Set Immediately (Bit 5) under SET status during position movement command, able to cancel currently operating position movement command and immediately move to new target position.

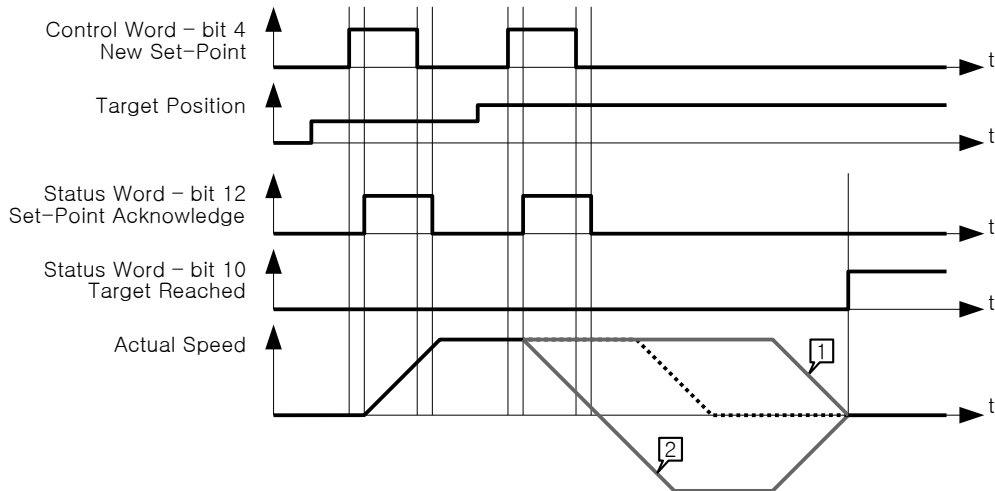

Figure 4.6: Change Set Immediately

1. If new target position is sufficiently ahead of previous target position, it will move to new target position passing by previous target position.
2. If new target position is behind of previous target position, it will be decelerated according to correspondent position and if need, it can stop and move to opposite direction.

If there is no previous position movement command or already completed, command under Change Set Immediately (Bit 5) under SET status is same as general position movement command.

4.6 Homing Mode

4.6.1 Definition

Homing Mode is the way of heading to origin with command of Control word (6040h). To use Homing Mode, need to set Homing Mode at Mode of operation (6060h). Able to use origin search command once Mode of operation display (6061h) indicates Homing Mode.

4.6.2 Relative Objects

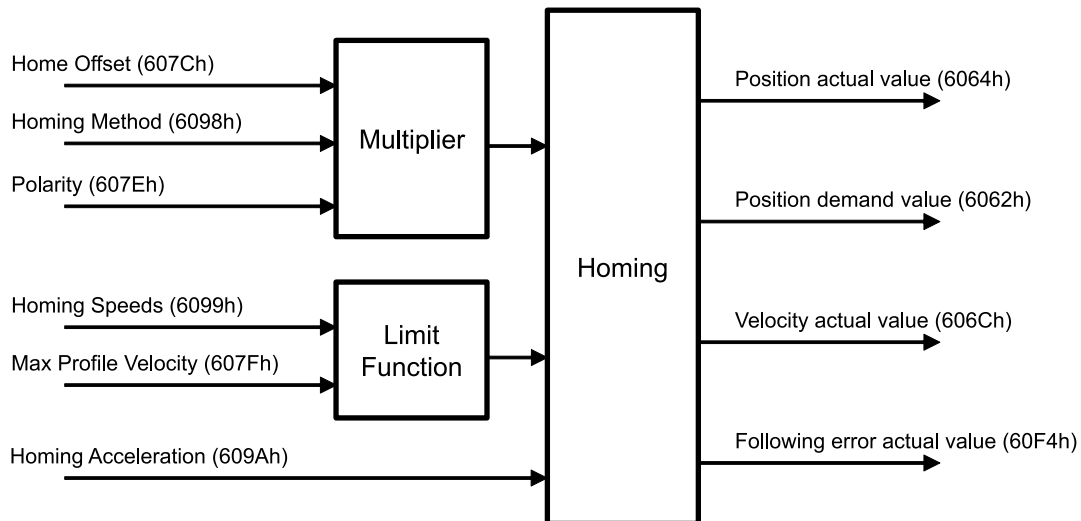

Figure 4.7: Homing Mode Objects

There are 3 kinds (Origin Switch, Positive Limit Switch, Negative Limit Switch) switches to find out origin. And it can be differentiated by Homing method (6098h).

If it is not Homing method by Limit Switch, once Limit Switch goes ON during origin searching, it will move to opposite direction against movement direction. During motion towards opposite direction, if opposite side of Limit Switch goes ON, origin search goes failure.

If Sensor origin and mechanical origin is different, able to set with using Home offset (607Ch). Once position of mechanical origin is set to Home Offset, Status word - bit 12: Home Attained is going to be ON and position objects will be initialized.

When Limit Switch is ON during Homing operation, it stops to change the direction. How to stop after detection of Limit Switch follows Object 2003h: Limit stop method setting.

4.6.3 Control word and Status word

Control word

Control word at Homing Mode are as follows.

| Bit 15 | Bit 14 | Bit 13 | Bit 12 | Bit 11 | Bit 10 | Bit 9 | Bit 8 |
|-------------|--------|--------|-------------------------------|------------------|------------|----------------|-------------|
| - | - | - | - | - | - | - | Halt |
| Bit 7 | Bit 6 | Bit 5 | Bit 4 | Bit 3 | Bit 2 | Bit 1 | Bit 0 |
| Fault Reset | - | - | Homing Operation Start | Enable Operation | Quick Stop | Enable Voltage | Switch On |

Table 4.19: Control word under Homing Mode

The functions of bits added in Homing Mode are as follows.

| Bit | Value | Description |
|-----|-------|---|
| 4 | 0 → 1 | Initiate origin search command. |
| 8 | 1 | Origin search command canceled and stops according to set action at Halt option code (605Dh). |

Table 4.20: Bit description of Control word under Homing Mode

For other bits, please refer to [4.3 Control word](#).

Status word

Status word at Homing Mode are as follows.

| Bit 15 | Bit 14 | Bit 13 | Bit 12 | Bit 11 | Bit 10 | Bit 9 | Bit 8 |
|------------------|--------------------|--------------|-----------------|-----------------------|-------------------|-------------|--------------------|
| Safety Activated | - | Homing Error | Homing attained | Internal Limit Active | Target Reached | Remote | - |
| Bit 7 | Bit 6 | Bit 5 | Bit 4 | Bit 3 | Bit 2 | Bit 1 | Bit 0 |
| - | Switch on disabled | Quick stop | Voltage enabled | Fault | Operation enabled | Switched on | Ready to switch on |

Table 4.21: Status word under Homing Mode

Please refer to drive status control for the rest of bits.

| Bit 13 | Bit 12 | Bit 10 | Description |
|--------|--------|--------|--|
| x | x | 0 | Origin search operation is on-going. |
| 0 | 0 | 1 | Origin search operation canceled or not started yet. |
| 0 | 1 | 1 | Origin search has successfully completed. |
| 1 | 0 | 1 | Origin search has failed. Controller stops. |

Table 4.22: Bit description of Status word under Homing Mode

For other bits, please refer to [4.6 Status word](#).

4.6.4 Origin Search Method

Origin search methods supported by this product are as follows.

| Homing method | Name |
|---------------|---|
| 17 | Homing on Negative Limit Switch |
| 18 | Homing on Positive Limit Switch |
| 24 | Homing on Origin Switch (Positive Direction, Negative Edge) |
| 28 | Homing on Origin Switch (Negative Direction, Positive Edge) |
| 35 | Set the current position origin |
| 37 | Set the current position origin and reset current position |

Table 4.23: Homing Method List

Supported origin searching method lists can be also checked from Supported homing methods (60E3h). In the description below, 'Index pulse' refers to the Z-Phase signal of the encoder.

Method 17: Homing on Negative Limit Switch

Figure 4.8: Homing Method 17

In this homing method, it start to move in the negative direction and the speed is Speed during search for switch (6099h, Sub-Index 1), until Negative Limit Switch is detected.

When a Negative Limit Switch is detected, it moves out of the Limit Switch at the speed of Speed during search for zero (6099h, Sub-Index 2) in the positive direction and moves in the opposite direction to detect the Limit Switch again.

Then, it moves in the positive direction until Index Pulse is detected, and sets that position as sensor origin position.

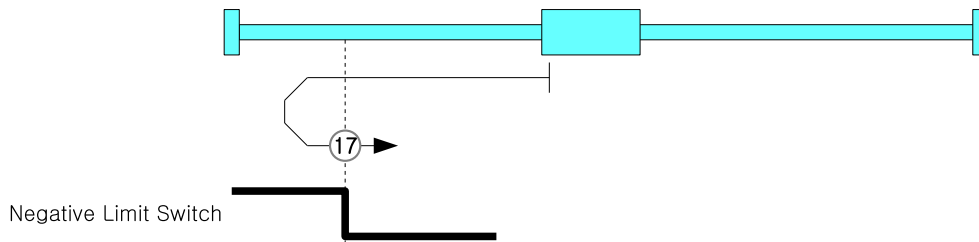
Method 18: Homing on Positive Limit Switch

Figure 4.9: Homing Method 18

In this homing method, it start to move in the positive direction and the speed is Speed during search for switch (6099h, Sub-Index 1), until Positive Limit Switch is detected.

When a Positive Limit Switch is detected, it moves out of the Limit Switch at the speed of Speed during search for zero (6099h, Sub-Index 2) in the negative direction and moves in the opposite direction to detect the Limit Switch again.

Then, it moves in the negative direction until Index Pulse is detected, and sets that position as sensor origin position.

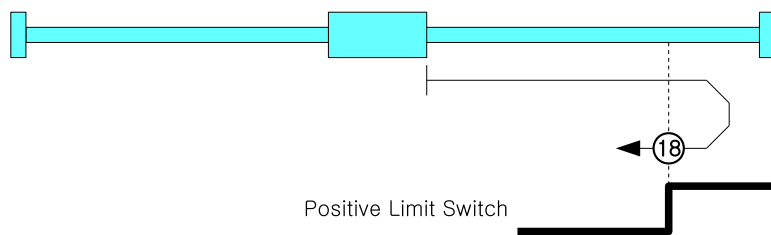
Method 24: Homing on Origin Switch (Positive Direction, Negative Edge)

Figure 4.10: Homing Method 24

In this homing method, it start to move in the positive direction and the speed is Speed during search for switch (6099h, Sub-Index 1), until Origin Switch is detected. If a Positive Limit Switch is detected, it moves in the opposite direction until the Origin Switch is detected.

When a Origin Switch is detected, it moves out of the Origin Switch at the speed of Speed during search for zero (6099h, Sub-Index 2) in the negative direction and moves in the opposite direction to detect the Origin Switch again, and sets that position as sensor origin position.

Method 28: Homing on Origin Switch (Negative Direction, Positive Edge)

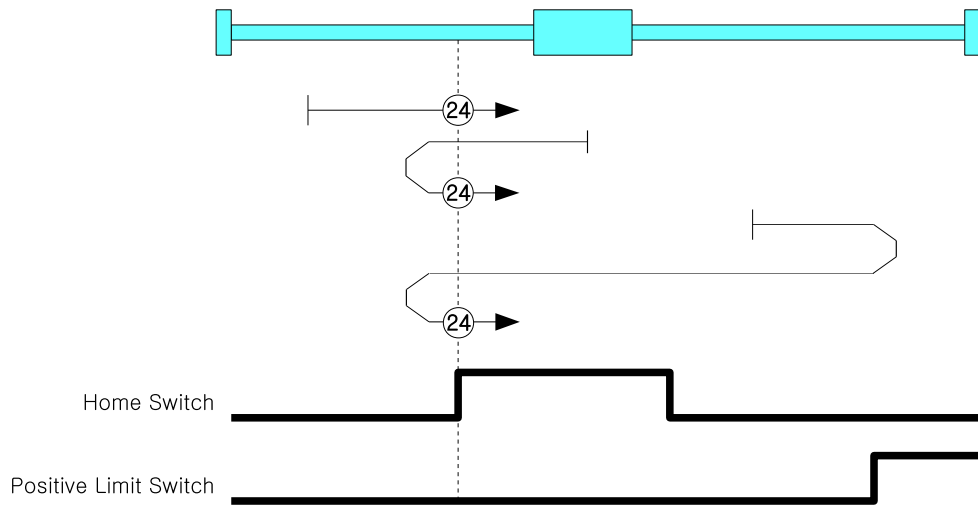
Figure 4.11: Homing Method 28

In this homing method, it start to move in the negative direction and the speed is Speed during search for switch (6099h, Sub-Index 1), until Origin Switch is detected. If a Negative Limit Switch is detected, it moves in the opposite direction until the Origin Switch is detected.

When a Origin Switch is detected, it moves out of the Origin Switch at the speed of Speed during search for zero (6099h, Sub-Index 2) in the positive direction and moves in the opposite direction to detect the Origin Switch again, and sets that position as sensor origin position.

Method 35: Set the current position origin

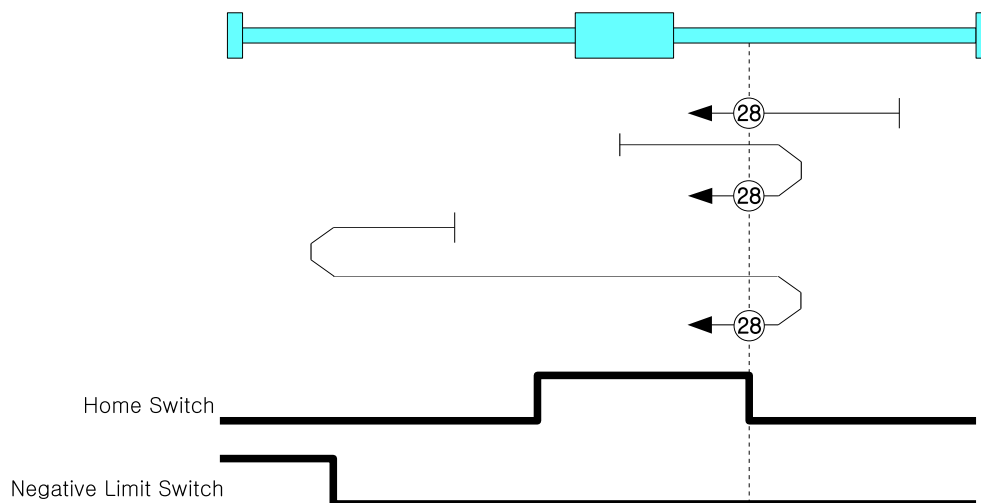
This origin search method is to set current position as sensor origin position.

Method 37: Set the current position origin and reset current position

This origin search method is to set current position as sensor origin position. If set value of Home offset (607Ch) is not 0, initialize current position as Home offset value.

4.7 Touch Probe

4.7.1 Definition

Touch probe function is to record current position with sensing inputs from external signal.

4.7.2 Related Objects

| Object | Description |
|---|--|
| Touch probe function (60B8h) | Control Touch Probe 1/2. |
| Touch probe status (60B9h) | Indicate status of Touch Probe 1/2. |
| Touch probe 1 positive value (60BAh) | Indicate detected position of Rising edge of Touch Probe 1. |
| Touch probe 1 negative value (60BBh) | Indicate detected position of Falling edge of Touch Probe 1. |
| Touch probe 2 positive value (60BCCh) | Indicate detected position of Rising edge of Touch Probe 2. |
| Touch probe 2 negative value (60BDh) | Indicate detected position of Falling edge of Touch Probe 2. |
| Touch probe 1 positive edge counter (60D5h) | Indicate the number of times the Rising edge of Touch Probe 1 was detected. |
| Touch probe 1 negative edge counter (60D6h) | Indicate the number of times the Falling edge of Touch Probe 1 was detected. |
| Touch probe 2 positive edge counter (60D7h) | Indicate the number of times the Rising edge of Touch Probe 2 was detected. |
| Touch probe 2 negative edge counter (60D8h) | Indicate the number of times the Falling edge of Touch Probe 1 was detected. |
| Touch probe source (60D0h) | Select input signal of Touch Probe 1/2. |

Table 4.24: Touch Probe related Objects

4.7.3 Touch Probe Status and Control

Touch Probe Operation : Acknowledge initial signal

If Touch probe function of bit number 1, 9 has set as 0, Touch probe only uses initially acknowledged signal after Enable.

Please refer to Timing chart as follow.

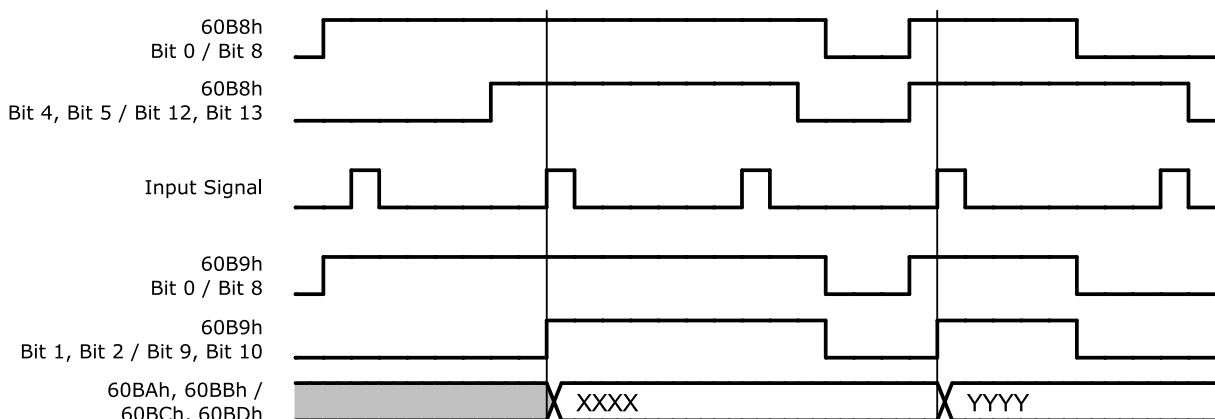

Figure 4.12: Touch Probe Operation (Bit 1 / Bit 9 = 0)

Able to check whether input signal acknowledged through Touch probe status of bit number 1 ~ 2, 9 ~ 10 (Detected).

Acknowledged position value, please check Touch probe 1 positive value, Touch probe 2 positive value, Touch probe 1 negative value, Touch probe 2 negative value.

Touch Probe Operation : Continuous signal acknowledgement

If Touch probe function of bit number 1, 9 has set as 1, Touch probe uses all acknowledged signals after Enable.

Please refer to Timing chart as follows.



Figure 4.13: Touch Probe Operation (Bit 1 / Bit 9 = 1)

Touch probe status of bit number 6 ~ 7, 14 ~ 15 (Counter) value increases every single of input signal acknowledgement. (Range of this value is 0 ~ 3.)

For the frequency of input signal acknowledgement, please check Touch probe 1 positive edge counter, Touch probe 2 positive edge counter, Touch probe 1 negative edge counter, Touch probe 2 negative edge counter.

4.8 Digital Input and Output

4.8.1 Definition

Ezi-STEPII EtherCAT provides 3 default input (ORIGIN, LIMIT+, LIMIT-) and 7 user inputs and also 1 default output (BRAKE) and 6 user outputs.

4.8.2 Related Objects

| Object | Access | Description |
|---|--------|---|
| Object 60FDh: Digital inputs | RO | Indicates input signals. |
| Object 60FEh: Digital outputs Sub-Index 1 - Physical Outputs | R/W | Set output signals. |
| Sub-Index 2 - Bit Mask | R/W | Set output signals. |
| Object 2001h: Sensors logics | R/W | Set Active Level of ORIGIN, LIMIT+, LIMIT- input signals. |
| Object 2002h: Reverse limit direction | R/W | Exchange LIMIT+ and LIMIT- input signals. |
| Object 2011h: Digital input levels | R/W | Active Level of user inputs. |
| Object 2012h: Digital output levels | R/W | Active Level of user outputs. |
| Object 2010h: Brake delay | R/W | Set Delay at BRAKE output. |

Table 4.25: I/O related Objects

4.8.3 User I/O

Able to set Active Level of user I/O through Digital input levels, Digital output levels.

Following picture describes the relationship between Digital inputs and Digital input levels and Digital outputs and Digital output levels.

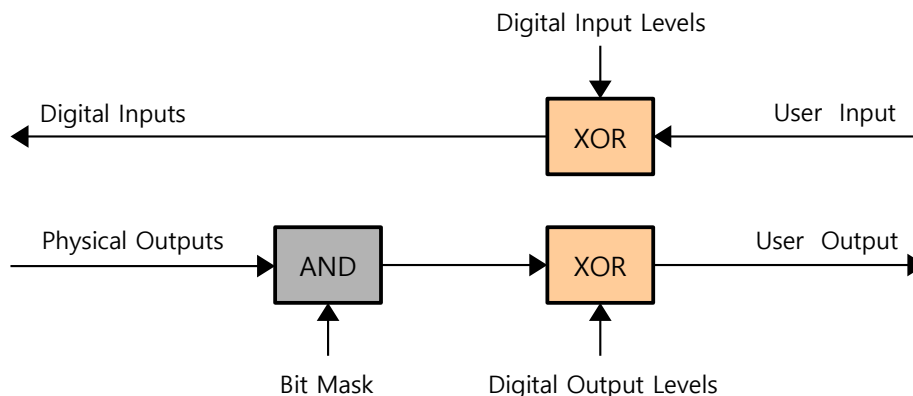
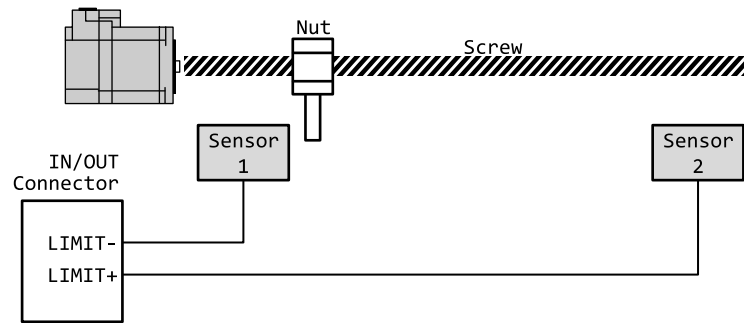

Figure 4.14: Digital I/O Level

4.8.4 ORIGIN and LIMIT Input

Active Level of ORIGIN and LIMIT input signal can be changed through Sensors logics (2001h) of Bit 0, 1. Please refer to Sensors logics.

LIMIT+ and LIMIT- input signals can be exchanged through Reverse limit direction (2002h). Interrelation between Reverse limit direction (2002h) and LIMIT+, LIMIT- is as follows.



| Reverse Limit Direction | Sensor 1 Detect | Sensor 2 Detect |
|-------------------------|-----------------|-----------------|
| 0 | Negative Limit | Positive Limit |
| 1 | Positive Limit | Negative Limit |

Table 4.26: Relationship between Reverse limit direction (2002h) and Limit Sensor

4.8.5 BRAKE Output

BRAKE output signal activates according to Operation Enabled of Status word (6041h). Timing of BRAKE ON can be set by Brake delay (2010h).

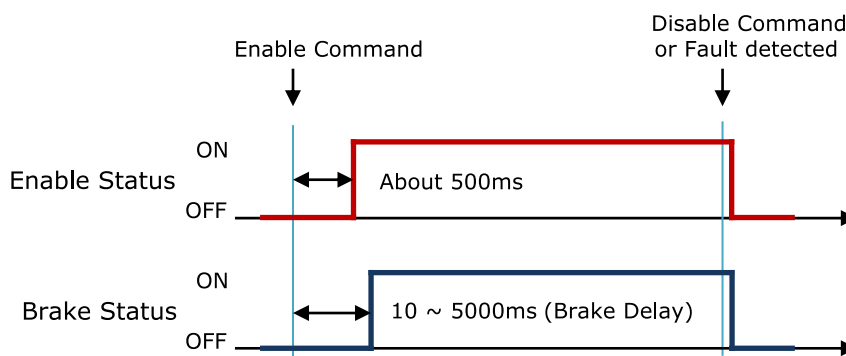

Figure 4.15: Brake Signal

BRAKE output can be manually released through Digital outputs (60FEh) Bit 0:Set Brake. For more detail information, please refer to [6.5.41 Object 60FEh: Digital outputs](#).

4.9 Safety Function

The 'Safety Function' allows the motor to shutdown and stop the motor in emergency situation or to protect the operator or equipment.

When the 'Safety Function' is activated, the motor is shut off and the motor stops by inertia. However, the control of the drive (except the motor power) and EtherCAT communication are normally performed. Digital Inputs and Digital Output can be used as Safety Function. The setting and monitoring status of Safety Function are available by using Object 2040h: Safety Mode. For the detail, please refer to [6.6.20 Object 2040h: Safety Mode](#).

Information

Safety Function feature is supported on devices with Software version (100Ah) 02.02.31 or higher.



4.9.1 Operation of Safety Function

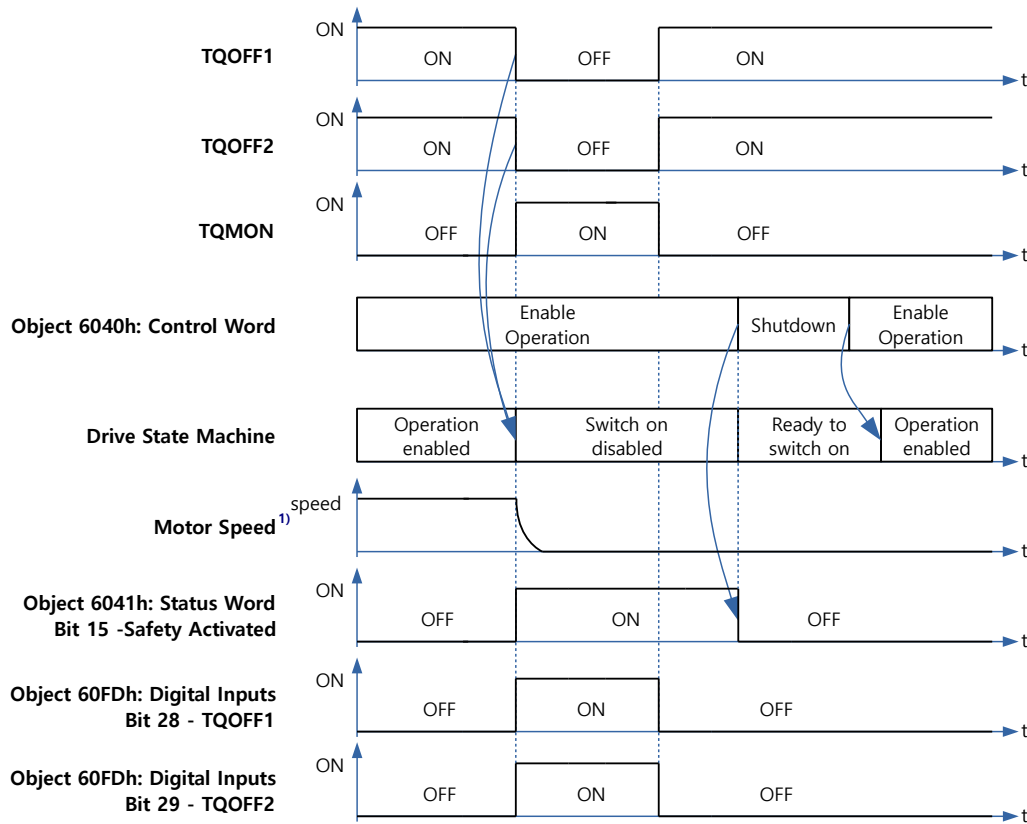

Figure 4.16: Safety Function Timing Chart

Information

The ON/OFF status of TQOFF1, TQOFF2, and TQMON means the conduction/non-conduction state of the photocoupler of the corresponding signals.



Activation

When the TQOFF Inputs are OFF, the Safety Function is activated. When the Safety Function is activated, the power supplied to the motor is cut off and Drive State Machine changes to the Switch on disabled state. Safety Activated (Bit 15 of Status word) indicates the activation status of the Safety Function.

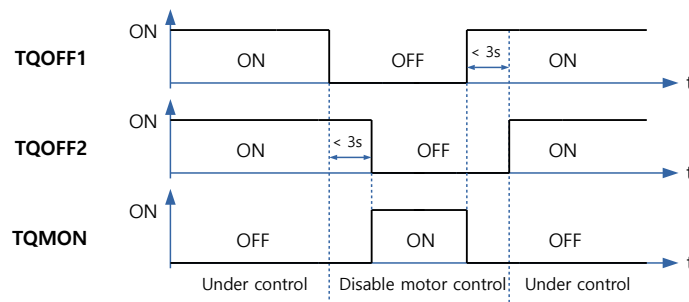

Figure 4.17: TQOFF Input (Normal Operation 1)

¹If the Safety Function is activated while the motor is moving, the power of motor is cut off and stopped by inertia.

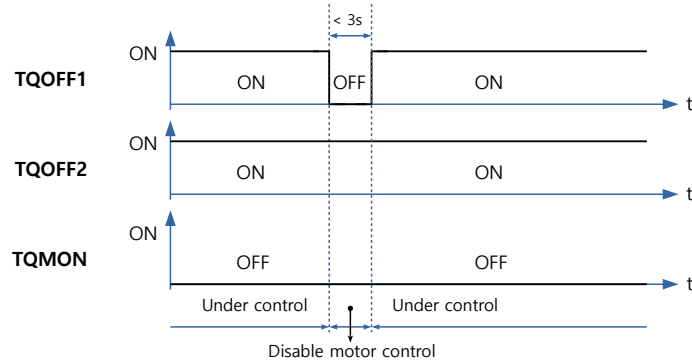

Figure 4.18: TQOFF Input (Normal Operation 2)

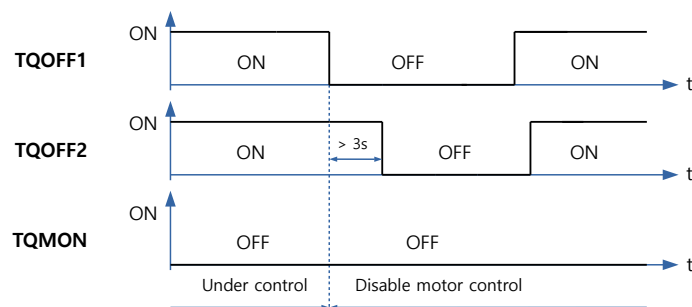

Figure 4.19: TQOFF Input (Fault Operation)

Information

By setting 'Transit to Fault state when Safety activated' of Advanced settings (2030h), an alarm can be set to occur when the Safety function is activated.

**Abnormal Safety Input State**

If the status of TQOFF1 and TQOFF2 are different from each other for more than 3 seconds, 'FF4Bh - abnormal safety status' alarm¹ occurs. The 'Abnormal Safety Input State' alarm can be clear by recycling the power of the controller. It can not clear by 'Fault Reset' command of Control word.

Deactivation

Even if the TQOFF Inputs are changed to ON again, the activated Safety Function is not deactivated automatically. To deactivate the Safety Function, do the following.

- Confirm that all the TQOFF Inputs are ON.
- Use the Shutdown command in Control word to command the Safety Function to deactivate.

When the Safety Function is deactivated, bit 15 of Status word - Safety Activated is turned off and the motor can be powered on again. Refer to [4.1 Drive Status Control](#) for information how to power on or what Drive State Machine is.

¹Please refer to [4.2 Error Code](#) for alarm occurrence and confirmation.

Chapter 5

Operation

5.1 Operation Sequence

Sequence of controller operation is as follow. Exampled operation sequence of Profile Position Mode listed at the table as below..

| Step | | Name | Action |
|------|-----------|--------------------------|--|
| 1 | Setting | Installation | Install motor/controller according to conditions of installation. |
| 2 | | Wiring | Check power cable, motor/encoder cable, I/O cable, EtherCAT communication cables are properly connected. |
| 3 | | Input power | Turn power on. Check controller status. |
| 4 | | PDO Mapping | Set Module/PDO Mapping. |
| 5 | | Set communication status | Change EtherCAT State Machine as 'Operational' |
| 6 | Operation | Control Drive Status | Set Control Word then change Drive State Machine to Operation Enabled. |
| 7 | | Set Mode | Set Object 6060h: Mode of operation. |
| 8 | | Set Operation | Input value into Object needed for execution of Motion. |
| 9 | | Movement Command | Execute command by setting of Control word. |
| 10 | | Check Status | Check the status of Motion execution. |
| 11 | | Set Drive | Reset object if need. |

5.2 Setting

5.2.1 Installation

Install motor/controller according to conditions of installation. Check operation in advance under unload status and recommend to connect Load. Please refer to [2.1 Precautions of Installation](#)

5.2.2 Wiring

Check power cable, motor/encoder cable, I/O cable, EtherCAT communication cables are properly connected. Please refer to [2.2 System Configuration](#)

5.2.3 Input Power

Turn power onto controller and check followings.

- Check Power LED (Red Color) of Drive status LED lights.
- Check 7-Segment indicates 0 or other value.

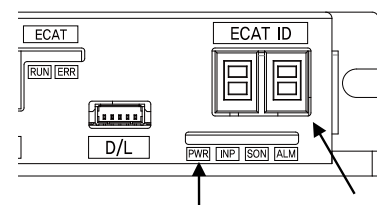

5.2.4 PDO Mapping

Set Module and PDO Mapping by setting function of Master.

Information

Trial operation explains operation by Profile Position Mode.
 Select the Module: 'Axis (Normal) : dynamic select operation mode'.
 Name of Module can be differentiated by each Master.



5.2.5 Set Communication Status

Change EtherCAT State Machine as 'Operational' status by controlling Master.

- Check State Machine of Master can be changing to 'Operational' status.
- Check State Machine of Controller can be changing to 'Operational' status.

5.3 Operation

5.3.1 Drive Status Control

Change Drive State Machine as 'Operation Enabled' by setting of Control word (6040h).

- Check Status word (6041h) whether it can be changing to 'Operation Enabled'.
- In case of changing to 'Fault' status, check type of error by Error code (603Fh). Execute appropriate action according to type of error.

5.3.2 Set Mode

Set Mode of operation (6060h) according to operation mode will be used.

Information

Trial operation explains operation by Profile Position Mode.
Set Mode of operation (6060h) at 1.



- Check Mode of operation display (6061h) whether it has properly changed.

5.3.3 Set Operation

Set Objects according to Motion will be executed.

Information

Trial operation explains operation by Profile Position Mode.
Input 10000 at Target position (607Ah).
Input 1000 at Profile velocity (6081h).



5.3.4 Movement Command

Once setting of Motion related Object has completed, execute movement command by setting of Control word.

Information

Trial operation explains operation by Profile Position Mode.
Input 005Fh at Control word. This command is to rotate motor by setting value(distance) at Target position.



5.3.5 Check Statuses

Check motor operates according to command or whether fault generated.

- Check motor achieves set operation visually.
- Check noise or abnormal vibration from motor during operation.
- After completion of motor operation, check Status word whether 'Target Reached' shown as 1.
- Check Status word whether 'Fault' shown as 1. If so, check Error code and execute appropriate action.

5.4 Drive Setting Adjustment

5.4.1 Change Rotation Direction

If rotation direction of motor goes opposite direction, set Polarity (607Eh) value then able to change rotation direction of motor.

Reverse limit direction

After changing Polarity, if LIMIT+, LIMIT- input signal acknowledgement reversed, able to change input value of 2 signals by setting the value of Reverse limit direction (2002h).

Regarding relationship between Reverse limit direction and Limit Sensors, please refer to [4.8.5 BRAKE Output](#).

5.4.2 Change I/O Signal Level

LIMIT+, LIMIT-, ORIGIN Input Signal

If Active Level of LIMIT+, LIMIT-, ORIGIN input signal has set different from actual connection, indication value of Actual signal input and Digital inputs can be different.

Reset Active Level of signals by setting the value of Sensors logics (2001h).

Able to set Active Level of Origin signal by Sensors logics.

User I/O

Active Level of User I/O, User Input 1 ~ 7 and User Output 1 ~ 6 can be changing by Digital input levels (2011h) and Digital output levels (2012h).

Chapter 6

EtherCAT Object Dictionary

6.1 Indication Type of Objects

Following table explains indication type of information for each object.

| Index | Sub index | Name | Type | Access | SAVE | PDO Mapping | Value Range | Default Value |
|-------|-----------|---------------------------------|------|--------|------|-------------|-------------|---------------|
| 60C2h | 0 | Number of entries | U8 | RO | No | No | | 2 |
| | 1 | Interpolation time period value | U8 | RW | Yes | No | 0 ~ 255 | 2 |
| | 2 | Interpolation time index | I8 | RW | Yes | No | -4 ~ 1 | -3 |

Object indicates default information as like Device name (1008h), it is indicated as following type.

| Index | Sub index | Name | Type | Access | Constant Value |
|-------|-----------|-------------|---------|--------|----------------------|
| 1008h | 0 | Device name | STR(18) | RO | Ezi-STEP II EtherCAT |

6.1.1 Index and Sub-Index

All object divides into 4 digits of hexadecimal index and configured as following field.

| Index | Field | Description |
|---------------|----------------------------------|---|
| 1000h ~ 1FFFh | Communication profile area | Objects that sets EtherCAT communication related settings or display status or information. |
| 2000h ~ 5FFFh | Manufacture specific area | FASTECH only Objects. |
| 6000h ~ 9FFFh | Standardized Device Profile Area | Objects defined in the CiA402 Drive Profile. |

Table 6.1: Index Table of Objects

If various parameter combined at the one object, able to access through Sub-Index. Please refer to each object of Sub-Index 0 : 'Number of entries' for Max. accessible Sub-Index.

6.1.2 Name

Describes correspondent object.

6.1.3 Data Type

Parameter type of object is as follows.

| Data Type | Length | Range |
|-----------|--------|------------------------------------|
| U8 | 1 byte | 0 ~ 255 |
| U16 | 2 byte | 0 ~ 65535 |
| U32 | 4 byte | 0 ~ 4294967295 |
| I8 | 1 byte | -128 ~ 127 |
| I16 | 2 byte | -32768 ~ 32767 |
| I32 | 4 byte | -2147483648 ~ 2147483647 |
| BOOL | 1 bit | 0 ~ 1 |
| STR(n) | | Character string which length is n |

Table 6.2: Data Type

6.1.4 Access

Property of each object is as following and describes authority to access each object.

| Access | Description |
|--------|--|
| RO | Read Only / Parameter only can be read. |
| RW | Read/Write / Parameter can be read or written. |

Table 6.3: Access type of object

6.1.5 SAVE

Value of object can be saved at EEPROM through Store parameters (1010h).

6.1.6 PDO Mapping

Indicates object whether correspondent object can be mapping at PDO communication of EtherCAT.

| PDO Type | Description |
|----------|-----------------------------------|
| No | Object can not be mapping at PDO. |
| TxPDO | Object can be mapping at TxPDO. |
| RxPDO | Object can be mapping at RxPDO. |

Table 6.4: PDO Mapping Description

6.1.7 Constant Value

Default value what correspondent object indicates. correspondent value can be differentially indicated by model or version of product.

6.1.8 Value Range

Value Range indicates input range of correspondent object. correspondent range can be indicated as any range or range of data type can be indicated.

6.1.9 Default Value

Indicates basic value of correspondent object. Can be initialized as a correspondent value when returns back to initial value through Restore default parameters (1011h).

6.2 Communication Object

6.2.1 Object 1000h: Device type

| Index | Sub index | Name | Type | Access | Constant Value |
|-------|-----------|-------------|------|--------|----------------|
| 1000h | 0 | Device type | U32 | RO | 0004 0192h |

Object includes information of Device Type.

| Bit | Name | Value | Description |
|---------|-----------------------|-------|----------------|
| 0 ~ 15 | Device Profile Number | 0192h | CiA402 Profile |
| 16 ~ 23 | Type | 04h | Stepper Driver |
| 24 ~ 31 | Mode | 00h | |

Table 6.5: Device Type

6.2.2 Object 1001h: Error register

| Index | Sub index | Name | Type | Access | SAVE | PDO Mapping | Value Range | Default Value |
|-------|-----------|----------------|------|--------|------|-------------|-------------|---------------|
| 1001h | 0 | Error register | U8 | RO | No | No | | 00h |

This object indicates type of error generated from the controller.

| Bit 7 | Bit 6 | Bit 5 | Bit 4 | Bit 3 | Bit 2 | Bit 1 | Bit 0 |
|----------------------|-------|-------------------------|---------------------|-------------------|---------------|---------------|---------------|
| Manufacture specific | - | Device profile specific | Communication error | Temperature error | Voltage error | Current error | Generic error |

Table 6.6: Error register

correspondent bit can be set if correspondent error generated. 'General Error' always goes to be set once bit error generated.

6.2.3 Object 1008h: Device name

| Index | Sub index | Name | Type | Access | Constant Value |
|-------|-----------|-------------|---------|--------|----------------------|
| 1008h | 0 | Device name | STR(18) | RO | Ezi-STEP II EtherCAT |

This object indicates name of device.

Information

The value of Device name can be differentially indicated by product model.



6.2.4 Object 1009h: Hardware version

| Index | Sub index | Name | Type | Access | Constant Value |
|-------|-----------|------------------|--------|--------|----------------|
| 1009h | 0 | Hardware version | STR(8) | RO | 01.00.00 |

This object indicates version of product hardware. Indicated value can be different by version of product.

6.2.5 Object 100Ah: Software version

| Index | Sub index | Name | Type | Access | Constant Value |
|-------|-----------|------------------|--------|--------|----------------|
| 100Ah | 0 | Software version | STR(8) | RO | 01.00.00 |

This object indicates version of software. Indicated value can be different by version of product.

6.2.6 Object 1010h: Store parameters

| Index | Sub index | Name | Type | Access | SAVE | PDO Mapping | Value Range | Default Value |
|-------|-----------|-------------------|------|--------|------|-------------|-------------|---------------|
| 1010h | 0 | Number of entries | U8 | RD | No | No | | 1 |
| | 1 | Store parameters | U32 | RW | No | No | | |

Able to save all storable object into EEPROM through this object.
Need to input '65766173h' into Sub-Index 01h to store objects into EEPROM.

| | MSB | | | LSB |
|-------|-----|-----|-----|-----|
| ASCII | 'e' | 'v' | 'a' | 's' |
| Hex | 65h | 76h | 61h | 73h |

Table 6.7: Definition of Save Parameters Value

If fails to store, SDO Communication returns 'Abort SDO Transfer (abort code: 0606 0000h)'. If inputs incorrect value, device does not store EEPROM and returns 'Abort SDO Transfer (abort code:0800 002xh)'.

When reads Sub-Index 01h, following value will be returned.

| Bit | Value | Description |
|--------|-------|-------------------------|
| 0 | 1 | Support save Parameter. |
| 1 ~ 31 | 0 | - |

Table 6.8: Save Parameters State

Check 'SAVE' part for each object.

6.2.7 Object 1011h: Restore default parameters

| Index | Sub index | Name | Type | Access | SAVE | PDO Mapping | Value Range | Default Value |
|-------|-----------|----------------------------|------|--------|------|-------------|-------------|---------------|
| 1011h | 0 | Number of entries | U8 | RD | No | No | | 1 |
| | 1 | Restore default parameters | U32 | RW | No | No | | |

It requests to device to restore objects value back to Default value to store into EEPROM.
Need to input '64616F6Ch' into Sub-Index 01h to restore objects back to original setting value.

| | MSB | | | LSB |
|-------|-----|-----|-----|-----|
| ASCII | 'd' | 'a' | 'o' | 'l' |
| Hex | 64h | 61h | 6Fh | 6Ch |

Table 6.9: Definition of Restore Parameters Value

If failed to initialize, SDO communication returns 'Abort SDO Transfer (abort code: 0606 0000h)'. If inputs incorrect value, device will not be initialized and return 'Abort SDO Transfer (abort code: 0800002xh)'.

Information

the objects' value will be set to default after power cycle.



In case of reading Sub-Index 01h, following values will be returned.

| Bit | Value | Description |
|--------|-------|------------------------------------|
| 0 | 1 | Support Restore Default Parameter. |
| 1 ~ 31 | 0 | - |

Table 6.10: Restore Parameters State

6.2.8 Object 1018h: Identity

| Index | Sub index | Name | Type | Access | Constant Value |
|-------|-----------|-------------------|------|--------|----------------|
| 1018h | 0 | Number of entries | U8 | RO | 4 |
| | 1 | Vendor ID | U32 | RO | 0FA0 0000h |
| | 2 | Product code | U32 | RO | 0000 1001h |
| | 3 | Revision number | U32 | RO | 0000 0000h |
| | 4 | Serial number | U32 | RO | 0000 0000h |

This object indicates information of device.

Information

Value for each item of Identity can be differentially indicated by product model and version.



6.2.9 Object 10F1h: Error settings

| Index | Sub index | Name | Type | Access | SAVE | PDO Mapping | Value Range | Default Value |
|-------|-----------|--------------------------|------|--------|------|-------------|-------------|---------------|
| 10F1h | 0 | Number of entries | U8 | RO | No | No | | 2 |
| | 1 | Reserved | U32 | RO | No | No | | 1 |
| | 2 | Sync error counter limit | U16 | RW | No | No | 0 ~ 65535 | 12 |

Sync Error Counter Limit

This object sets the criteria for judging the failure to receive Process Data as a Communication Error when the Communication Synchronization type is DC Sync Event.

If product was not received the Process Data (SM Event does not occur) sent by the Master, 'Internal SM Event Missed Counter' increases by 3. Counter decreases by 1 when Process Data is normally received. If the counter exceeds the value set in the Sync Error Counter Limit, 'EtherCAT Communication Error (7500h)' occurs and the EtherCAT State Machine of the product is forcibly changed from OP to SAFE-OP. An example of increasing / decreasing of the 'Internal SM Event Missed Counter' is as follows when the Sync Error Counter Limit is 12:

| SM Event occur | Counter (changes) |
|----------------|-------------------------------|
| O | 0 (-1) |
| X | 3 (+3) |
| O | 2 (-1) |
| X | 5 (+3) |
| O | 4 (-1) |
| O | 3 (-1) |
| X | 6 (+3) |
| X | 9 (+3) |
| X | 12 (+3) / Communication error |

Table 6.11: Example of the Internal SM Event Missed Counter

6.2.10 Object 10F3h: Diagnosis history

| Index | Sub index | Name | Type | Access | SAVE | PDO Mapping | Value Range | Default Value |
|-------|-----------|-----------------------------|------|--------|------|-------------|-------------|---------------|
| 10F3h | 0 | Number of entries | U8 | RO | No | No | 5 ~ 50 | 5 |
| | 1 | Maximum messages | U8 | RO | No | No | 45 | 45 |
| | 2 | Newest message | U8 | RO | No | No | 0, 6 ~ 50 | 0 |
| | 3 | Newest acknowledged message | U8 | RW | No | No | 0, 6 ~ 50 | 0 |
| | 4 | New message available | BOOL | RO | No | TxPDO | 0 ~ 1 | 0 |
| | 5 | Flags | U16 | RW | No | No | | 00h |
| | 6 | Diagnosis message 1 | REC | RO | No | No | | |
| | 7 | Diagnosis message 2 | REC | RO | No | No | | |
| | . | . | | | | | | |
| | 50 | Diagnosis message 45 | REC | RO | No | No | | |

This object display the diagnosis messages that occurs inside the product.

Information

The objects of Diagnosis history are saved automatically and are not clear even when the product is turn off.

And, does not initialized by the command of Restore default parameters.



Maximum Messages

This object displays the maximum number of diagnosis messages supported by the product.

Newest Message

This object displays the Sub-Index number of the recently added diagnosis message. When a new diagnosis message occurs, Newest Message is incremented by 1, and the content of the diagnosis message is recorded in the 'Sub-Index' position.

The value of this object increases from 6, up to 50. At 50, when new diagnosis messages occur again, it increases again from 6. (i.e., if more than 45 diagnosis messages are generated, only 45 diagnosis messages remain and the oldest messages are erased.)

Newest Acknowledged Message

This object can set whether the diagnosis messages have been acknowledged.

By setting a number of 6 ~ 50 in this object, you can mark that you have checked the diagnosis message for that Sub-Index. However, if the number of unchecked diagnosis messages exceeds 45, the value of this object is initialized to 0 by itself.

You can set value to 0 to delete all diagnosis messages. Then, the values of all objects in Diagnosis history are initialized to their default values.

New Message Available

It displayed 1 when there are any not acknowledged diagnosis messages. It displayed 0 when all diagnosis messages are acknowledged by setting the Sub-Index value of the last diagnosis message in the Newest Acknowledged Message object.

Flags

| | | | | | | | |
|--------|--------|---------------------|----------------|-----------------------|-------------------------|----------------------|-------|
| Bit 15 | Bit 14 | Bit 13 | Bit 12 | Bit 11 | Bit 10 | Bit 9 | Bit 8 |
| - | - | - | - | - | - | - | - |
| Bit 7 | Bit 6 | Bit 5 | Bit 4 | Bit 3 | Bit 2 | Bit 1 | Bit 0 |
| - | - | Overwrite / Discard | Operation Mode | Disable Error Message | Disable Warning Message | Disable Info Message | - |

Table 6.12: Definition of Flags

- If the Disable Info Message bit is set to 1, no more 'Info' type of diagnosis messages are added.
- If the Warning Info Message bit is set to 1, no more 'Warning' type of diagnosis messages are added.
- If the Error Info Message bit is set to 1, no more 'Error' type of diagnosis messages are added.
- The Operation Mode bit sets how messages are stacked. 0 is Overwrite mode. The oldest message are Overwritten when more than 45 messages occur. 1 is Acknowledge mode. unacknowledged messages are not overwritten.
- The Overwrite / Discard bit is read-only. If the Operation Mode is Overwrite mode, this bit indicates that an unacknowledged message has been overwritten because more than 45 new messages have occurred. If the Operation Mode is Acknowledge mode, this bit indicated that there are 45 unacknowledged messages and the newly created messages were discarded.

Diagnosis Messages 1 ~ 45

This object is the content of the diagnosis message. it's a struct type, and it is as follows:

| Byte offset | Size | Name | Description |
|-------------|---------|-------------------|--|
| 0 | 4 bytes | Diag Code | Code of the Diagnosis Message. |
| 4 | 1 byte | Flags (type) | Type of message. 0 is Info, 1 is Warning, 2 is Error. |
| 5 | 1 byte | Flags (Param no.) | The number of 'Flags' and 'Parameter' below. |
| 6 | 2 bytes | Text ID | Text ID of the message. Please refer to the DiagMessages element of the Product's ESI file. |
| 8 | 8 bytes | Time Stamp | The time the message was recorded. |
| 16 | 2 bytes | Flags 1 | Type and size of Parameter 1. (1: BOOL, 2: INT8, 3: INT16, 4: INT32, 5: UINT8, 6: UINT16, 7: UINT32) |
| 18 | n bytes | Parameter 1 | 1st argument. |
| 18 + n | 2 bytes | Flags 2 | Type and size of Parameter 2. |
| 20 + n | n bytes | Parameter 2 | 2nd argument. |
| | | ... | |

Table 6.13: The structure of Diagnosis Message

6.3 PDO Mapping Object

6.3.1 Object 1600h: RxPDO-Map 0

| Index | Sub index | Name | Type | Access | SAVE | PDO Mapping | Value Range | Default Value |
|-------|-----------|-------------------|------|--------|------|-------------|-------------|---------------|
| 1600h | 0 | Number of entries | U8 | RW | No | No | 0 ~ 10 | 2 |
| | 1 | 1st PDO object | U32 | RW | No | No | | 6040 0010h |
| | 2 | 2nd PDO object | U32 | RW | No | No | | 607A 0020h |
| | 3 | 3rd PDO object | U32 | RW | No | No | | 0000 0000h |
| | 4 | 4th PDO object | U32 | RW | No | No | | 0000 0000h |
| | 5 | 5th PDO object | U32 | RW | No | No | | 0000 0000h |
| | 6 | 6th PDO object | U32 | RW | No | No | | 0000 0000h |
| | 7 | 7th PDO object | U32 | RW | No | No | | 0000 0000h |
| | 8 | 8th PDO object | U32 | RW | No | No | | 0000 0000h |
| | 9 | 9th PDO object | U32 | RW | No | No | | 0000 0000h |
| | 10 | 10th PDO object | U32 | RW | No | No | | 0000 0000h |

This object points RxPDO 0 information among RxPDO setting.

Following objects are basically mapping: Control word (6040h), Target position (607Ah)

RxPDO-Map 0 is configurable. Please refer to [3.2 PDO Mapping](#)

6.3.2 Object 1601h: RxPDO-Map 1

| Index | Sub index | Name | Type | Access | SAVE | PDO Mapping | Value Range | Default Value |
|-------|-----------|-------------------|------|--------|------|-------------|-------------|---------------|
| 1601h | 0 | Number of entries | U8 | RW | No | No | 0 ~ 10 | 10 |
| | 1 | 1st PDO object | U32 | RW | No | No | | 6040 0010h |
| | 2 | 2nd PDO object | U32 | RW | No | No | | 607A 0020h |
| | 3 | 3rd PDO object | U32 | RW | No | No | | 6081 0020h |
| | 4 | 4th PDO object | U32 | RW | No | No | | 6060 0008h |
| | 5 | 5th PDO object | U32 | RW | No | No | | 0000 0000h |
| | 6 | 6th PDO object | U32 | RW | No | No | | 0000 0000h |
| | 7 | 7th PDO object | U32 | RW | No | No | | 0000 0000h |
| | 8 | 8th PDO object | U32 | RW | No | No | | 0000 0000h |
| | 9 | 9th PDO object | U32 | RW | No | No | | 0000 0000h |
| | 10 | 10th PDO object | U32 | RW | No | No | | 0000 0000h |

This object points RxPDO 1 information among RxPDO setting. RxPDO-Map 1 is configurable. Please refer to [3.2 PDO Mapping](#).

6.3.3 Object 1A00h: TxPDO-Map 0

| Index | Sub index | Name | Type | Access | SAVE | PDO Mapping | Value Range | Default Value |
|-------|-----------|-------------------|------|--------|------|-------------|-------------|---------------|
| 1A00h | 0 | Number of entries | U8 | RW | No | No | 0 ~ 10 | 2 |
| | 1 | 1st PDO object | U32 | RW | No | No | | 6041 0010h |
| | 2 | 2nd PDO object | U32 | RW | No | No | | 6064 0020h |
| | 3 | 3rd PDO object | U32 | RW | No | No | | 0000 0000h |
| | 4 | 4th PDO object | U32 | RW | No | No | | 0000 0000h |
| | 5 | 5th PDO object | U32 | RW | No | No | | 0000 0000h |
| | 6 | 6th PDO object | U32 | RW | No | No | | 0000 0000h |
| | 7 | 7th PDO object | U32 | RW | No | No | | 0000 0000h |
| | 8 | 8th PDO object | U32 | RW | No | No | | 0000 0000h |
| | 9 | 9th PDO object | U32 | RW | No | No | | 0000 0000h |
| | 10 | 10th PDO object | U32 | RW | No | No | | 0000 0000h |

This object points TxPDO 0 information among TxPDO setting.

Following objects are already mapping: Status word (6041h), Position actual value (6064h)

TxPDO-Map 0 is configurable. Please refer to [3.2 PDO Mapping](#).

6.3.4 Object 1A01h: TxPDO-Map 1

| Index | Sub index | Name | Type | Access | SAVE | PDO Mapping | Value Range | Default Value |
|-------|-----------|-------------------|------|--------|------|-------------|-------------|---------------|
| 1A01h | 0 | Number of entries | U8 | RW | No | No | 0 ~ 10 | 10 |
| | 1 | 1st PDO object | U32 | RW | No | No | | 6041 0010h |
| | 2 | 2nd PDO object | U32 | RW | No | No | | 6064 0020h |
| | 3 | 3rd PDO object | U32 | RW | No | No | | 606C 0020h |
| | 4 | 4th PDO object | U32 | RW | No | No | | 6061 0008h |
| | 5 | 5th PDO object | U32 | RW | No | No | | 0000 0000h |
| | 6 | 6th PDO object | U32 | RW | No | No | | 0000 0000h |
| | 7 | 7th PDO object | U32 | RW | No | No | | 0000 0000h |
| | 8 | 8th PDO object | U32 | RW | No | No | | 0000 0000h |
| | 9 | 9th PDO object | U32 | RW | No | No | | 0000 0000h |
| | 10 | 10th PDO object | U32 | RW | No | No | | 0000 0000h |

This object points TxPDO 1 information among TxPDO.

TxPDO-Map 1 is configurable. Please refer to [3.2 PDO Mapping](#).

6.3.5 Object 1C12h: RxPDO assign

| Index | Sub index | Name | Type | Access | SAVE | PDO Mapping | Value Range | Default Value |
|-------|-----------|-------------------|------|--------|------|-------------|-------------|---------------|
| 1C12h | 0 | Number of entries | U8 | RO | No | No | | 1 |
| | 1 | RxPDO assign | U16 | RW | No | No | | 1600h |

6.3.6 Object 1C13h: TxPDO assign

| Index | Sub index | Name | Type | Access | SAVE | PDO Mapping | Value Range | Default Value |
|-------|-----------|-------------------|------|--------|------|-------------|-------------|---------------|
| 1C13h | 0 | Number of entries | U8 | RO | No | No | | 1 |
| | 1 | TxPDO assign | U16 | RW | No | No | | 1A00h |

6.4 Sync Manager Object

6.4.1 Object 1C00h: Sync manager type

| Index | Sub index | Name | Type | Access | Constant Value |
|-------|-----------|-------------------|------|--------|----------------|
| 1C00h | 0 | Number of entries | U8 | RO | 4 |
| | 1 | SM0 | U8 | RO | 01h |
| | 2 | SM1 | U8 | RO | 02h |
| | 3 | SM2 | U8 | RO | 03h |
| | 4 | SM3 | U8 | RO | 04h |

| Sync Manager Type | Description |
|-------------------|-------------|
| 1 | Mailbox Out |
| 2 | Mailbox In |
| 3 | PDO Output |
| 4 | PDO Input |

Table 6.14: Sync Manager Type Value

6.4.2 Object 1C32h: SM output parameter

| Index | Sub index | Name | Type | Access | SAVE | PDO Mapping | Value Range | Default Value |
|-------|-----------|--------------------------------|------|--------|------|-------------|-------------|---------------|
| 1C32h | 0 | Number of entries | U8 | RO | No | No | | 32 |
| | 1 | Synchronization type | U16 | RW | No | No | | 0002h |
| | 2 | Cycle time | U32 | RO | No | No | | 0000 0000h |
| | 4 | Synchronization type supported | U16 | RO | No | No | | 401Fh |
| | 5 | Minimum cycle time | U32 | RO | No | No | | 250000 |
| | 6 | Calc and copy time | U32 | RO | No | No | | 10000 |
| | 8 | Get cycle time | U16 | RW | No | No | | 0000h |
| | 9 | Delay time | U32 | RO | No | No | | 0000 0000h |
| | 10 | Sync0 cycle time | U32 | RW | No | No | | 0000 0000h |
| | 11 | SM-Event missed | U16 | RO | No | No | | 0000h |
| | 12 | Cycle time too small | U16 | RO | No | No | | 0000h |
| | 32 | Sync error | BOOL | RO | No | No | 0 ~ 1 | 0 |

6.4.3 Object 1C33h: SM input parameter

| Index | Sub index | Name | Type | Access | SAVE | PDO Mapping | Value Range | Default Value |
|-------|-----------|--------------------------------|------|--------|------|-------------|-------------|---------------|
| 1C33h | 0 | Number of entries | U8 | RO | No | No | | 32 |
| | 1 | Synchronization type | U16 | RW | No | No | | 0002h |
| | 2 | Cycle time | U32 | RO | No | No | | 0000 0000h |
| | 4 | Synchronization type supported | U16 | RO | No | No | | 401Fh |
| | 5 | Minimum cycle time | U32 | RO | No | No | | 250000 |
| | 6 | Calc and copy time | U32 | RO | No | No | | 10000 |
| | 8 | Get cycle time | U16 | RW | No | No | | 0000h |
| | 9 | Delay time | U32 | RO | No | No | | 0000 0000h |
| | 10 | Sync0 cycle time | U32 | RW | No | No | | 0000 0000h |
| | 11 | SM-Event missed | U16 | RO | No | No | | 0000h |
| | 12 | Cycle time too small | U16 | RO | No | No | | 0000h |
| | 32 | Sync error | BOOL | RO | No | No | 0 ~ 1 | 0 |

6.5 Drive Profile Object

6.5.1 Object 603Fh: Error code

| Index | Sub index | Name | Type | Access | SAVE | PDO Mapping | Value Range | Default Value |
|-------|-----------|------------|------|--------|------|-------------|-------------|---------------|
| 603Fh | 0 | Error code | U16 | RW | No | TxPDO | | 0000h |

This object indicates latest error value generated from controller.
Please refer to [4.2 Error Code](#) for the value of indicated value at Error code.

6.5.2 Object 6040h: Control word

| Index | Sub index | Name | Type | Access | SAVE | PDO Mapping | Value Range | Default Value |
|-------|-----------|--------------|------|--------|------|-------------|-------------|---------------|
| 6040h | 0 | Control word | U16 | RW | No | RxPDO | | 0000h |

This object controls device status
Each bit of this object has a meaning as follows.

| Bit 15 | Bit 14 | Bit 13 | Bit 12 | Bit 11 | Bit 10 | Bit 9 | Bit 8 |
|--------------|--------|--------|--------|------------------|------------|----------------|-----------|
| - | - | oms | | - | - | - | Halt |
| Bit 7 | Bit 6 | Bit 5 | Bit 4 | Bit 3 | Bit 2 | Bit 1 | Bit 0 |
| Fault Re-set | oms | | | Enable Operation | Quick Stop | Enable Voltage | Switch On |

Table 6.15: Definition of Control word

For details, please refer to each profile description.

6.5.3 Object 6041h: Status word

| Index | Sub index | Name | Type | Access | SAVE | PDO Mapping | Value Range | Default Value |
|-------|-----------|-------------|------|--------|------|-------------|-------------|---------------|
| 6041h | 0 | Status word | U16 | RO | No | TxPDO | | 0000h |

This object indicates the status of controller.
Each bit of this object has a meaning as follows.

| Bit 15 | Bit 14 | Bit 13 | Bit 12 | Bit 11 | Bit 10 | Bit 9 | Bit 8 |
|------------------|--------------------|------------|-----------------|-----------------------|-------------------|-------------|--------------------|
| Safety Activated | oms | | | Internal Limit Active | oms | Remote | oms |
| Bit 7 | Bit 6 | Bit 5 | Bit 4 | Bit 3 | Bit 2 | Bit 1 | Bit 0 |
| - | Switch on disabled | Quick stop | Voltage enabled | Fault | Operation enabled | Switched on | Ready to switch on |

Table 6.16: Definition of Status word

For details, please refer to each profile description.

6.5.4 Object 605Ah: Quick stop option code

| Index | Sub index | Name | Type | Access | SAVE | PDO Mapping | Value Range | Default Value |
|-------|-----------|------------------------|------|--------|------|-------------|-------------|---------------|
| 605Ah | 0 | Quick stop option code | I16 | RW | Yes | No | 0 ~ 2, 5, 6 | 2 |

This object sets motion of immediate stop once controller status is Quick Stop.

| Value | Description |
|-------|---|
| 0 | Torque-Disable. Motor Free |
| 1 | After decelerated stop, changes to be 'switch On Disable' status. |
| 2 | After quick stop, changes to be 'Switch On Disable' status. |
| 5 | After decelerated stop, stay in 'Quick Stop Active' status. |
| 6 | After quick stop, stay in 'Quick Stop Active' status. |

Table 6.17: Quick Stop Option Code

6.5.5 Object 605Bh: Shutdown option code

| Index | Sub index | Name | Type | Access | SAVE | PDO Mapping | Value Range | Default Value |
|-------|-----------|----------------------|------|--------|------|-------------|-------------|---------------|
| 605Bh | 0 | Shutdown option code | I16 | RW | Yes | No | 0 ~ 1 | 0 |

This object is to set motion when controller goes Shutdown status.

| Value | Description |
|-------|--|
| 0 | Torque-Disable. Motor Free |
| 1 | After decelerated stop, disable Motor. |

Table 6.18: Shutdown Option Code

6.5.6 Object 605Ch: Disable operation option code

| Index | Sub index | Name | Type | Access | SAVE | PDO Mapping | Value Range | Default Value |
|-------|-----------|-------------------------------|------|--------|------|-------------|-------------|---------------|
| 605Ch | 0 | Disable operation option code | I16 | RW | Yes | No | 0 ~ 1 | 1 |

This object is to set operation in case of deactivated operation once controller goes Disable Operation status.

| Value | Description |
|-------|--|
| 0 | Torque-Disable. Motor Free |
| 1 | After decelerated stop, disable Motor. |

Table 6.19: Disable Operation Option Code

6.5.7 Object 605Dh: Halt option code

| Index | Sub index | Name | Type | Access | SAVE | PDO Mapping | Value Range | Default Value |
|-------|-----------|------------------|------|--------|------|-------------|-------------|---------------|
| 605Dh | 0 | Halt option code | I16 | RW | Yes | No | 1 ~ 2 | 1 |

This object, Control word - bit 8: Set motion through Halt once stops command.

| Value | Description |
|-------|--|
| 1 | After decelerated stops, maintains Operation Enabled status. |
| 2 | After quick stops, maintain Operation Enabled status. |

Table 6.20: Halt Option Code

6.5.8 Object 605Eh: Fault reaction option code

| Index | Sub index | Name | Type | Access | SAVE | PDO Mapping | Value Range | Default Value |
|-------|-----------|----------------------------|------|--------|------|-------------|-------------|---------------|
| 605Eh | 0 | Fault reaction option code | I16 | RW | Yes | No | 0 ~ 2 | 2 |

This object is to set operation once error occurs.

| Value | Description |
|-------|----------------------------|
| 0 | Torque-Disable. Motor Free |
| 1 | Decelerated stops. |
| 2 | Quick stops. |

Table 6.21: Fault Reaction Option Code

6.5.9 Object 6060h: Mode of operation

| Index | Sub index | Name | Type | Access | SAVE | PDO Mapping | Value Range | Default Value |
|-------|-----------|-------------------|------|--------|------|-------------|-------------|---------------|
| 6060h | 0 | Mode of operation | I8 | RW | No | RxPDO | | 0 |

This object is to set operation mode.

| Value | Description | Abbreviation |
|-------|----------------------------------|--------------|
| 0 | Operation mode has not set | - |
| 1 | Profile Position Mode | PP |
| 6 | Homing Mode | HM |
| 8 | Cyclic Synchronous Position Mode | CSP |

Table 6.22: Mode of operation value

This object indicates operation mode currently requested. Current operation mode is indicated at Mode of operation display (6061h).

6.5.10 Object 6061h: Mode of operation display

| Index | Sub index | Name | Type | Access | SAVE | PDO Mapping | Value Range | Default Value |
|-------|-----------|---------------------------|------|--------|------|-------------|-------------|---------------|
| 6061h | 0 | Mode of operation display | I8 | RO | No | TxPDO | | 0 |

This object indicates current operation mode. Definition of value is same as Mode of operation (6060h).

6.5.11 Object 6062h: Position demand value

| Index | Sub index | Name | Type | Access | SAVE | PDO Mapping | Value Range | Default Value |
|-------|-----------|-----------------------|------|--------|------|-------------|-------------|---------------|
| 6062h | 0 | Position demand value | I32 | RO | No | TxPDO | | 0 |

This object indicates internal command position.

This position value is real time target position delivered from STEP Motor controller part to Motor.

6.5.12 Object 6064h: Position actual value

| Index | Sub index | Name | Type | Access | SAVE | PDO Mapping | Value Range | Default Value |
|-------|-----------|-----------------------|------|--------|------|-------------|-------------|---------------|
| 6064h | 0 | Position actual value | I32 | RO | No | TxPDO | | 0 |

This object indicates current position.

This position value indicates the value of Position demand value, not the Encoder value.

It can be set to display the position of the external encoder using Object 2004h: External Encoder. Please refer to the corresponding object.

6.5.13 Object 606Bh: Velocity demand value

| Index | Sub index | Name | Type | Access | SAVE | PDO Mapping | Value Range | Default Value |
|-------|-----------|-----------------------|------|--------|------|-------------|-------------|---------------|
| 606Bh | 0 | Velocity demand value | I32 | RO | No | TxPDO | | 0 |

This object indicates internal command velocity. The velocity value is a positive value when the motor rotates in the positive direction, and a negative value when the motor rotates in the negative direction.

Information

This object is supported only in Profile Position Mode and Homing Mode. 0 value is displayed in Cyclic Synchronous Position Mode.

**Information**

This object is supported on devices with Software version (100Ah) 02.02.26 or higher.

**6.5.14 Object 606Ch: Velocity actual value**

| Index | Sub index | Name | Type | Access | SAVE | PDO Mapping | Value Range | Default Value |
|-------|-----------|-----------------------|------|--------|------|-------------|-------------|---------------|
| 606Ch | 0 | Velocity actual value | I32 | RO | No | TxPDO | | 0 |

This object indicates internal command velocity. The velocity value is a positive value when the motor rotates in the positive direction, and a negative value when the motor rotates in the negative direction.

Information

This object does not display current actual velocity. it displays the same value as the value of Velocity demand value.

**6.5.15 Object 607Ah: Target position**

| Index | Sub index | Name | Type | Access | SAVE | PDO Mapping | Value Range | Default Value |
|-------|-----------|-----------------|------|--------|------|-------------|-----------------------------|---------------|
| 607Ah | 0 | Target position | I32 | RW | No | RxPDO | -2147483648 ~ 2147483647 | 0 |

This object sets target position under Profile Position Mode, Cyclic Synchronous Position Mode.

6.5.16 Object 607Ch: Home offset

| Index | Sub index | Name | Type | Access | SAVE | PDO Mapping | Value Range | Default Value |
|-------|-----------|-------------|------|--------|------|-------------|-----------------------------|---------------|
| 607Ch | 0 | Home offset | I32 | RW | Yes | No | -2147483648 ~ 2147483647 | 0 |

This object sets value of difference between sensor origin position and mechanical origin position. During Homing Mode, completes origin search by set mode at Home Method then moves by Home Offset distance. If set value is over 0, move toward +direction and less than 0, move toward -direction.

6.5.17 Object 607Dh: Software position limit

| Index | Sub index | Name | Type | Access | SAVE | PDO Mapping | Value Range | Default Value |
|-------|-----------|--------------------------|------|--------|------|-------------|-----------------------------|---------------|
| 607Dh | 0 | Number of entries | U8 | RO | No | No | | 2 |
| | 1 | Min position range limit | I32 | RW | Yes | No | -2147483648 ~ 2147483647 | -2147483648 |
| | 2 | Max position range limit | I32 | RW | Yes | No | -2147483648 ~ 2147483647 | 2147483647 |

Absolute position range where position objects can be positioned. Controller is unable to get out of this range. If needs to move position out of this range, target position can be adjusted within range and if current position currently is out of range, Status word of 'Internal Limit Active' Bit goes SET and unable to move to correspondent direction.

Software Position Limit is based on Sensor origin. If Home Offset has set by not 0 but other value, Actual Software Position Limit needs to be used after adjustment by Home Offset.

Actual movable Min. position = Min Position Limit - Home Offset

Actual movable Max. position = Max Position Limit - Home Offset

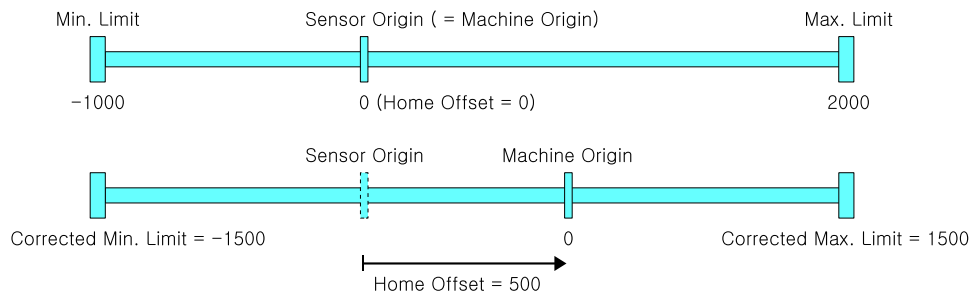

Figure 6.1: Origin Offset

Information

If you set both Min Position Range Limit and Max Position Range Limit to 0, you can disable the function of Software position limit.



6.5.18 Object 607Eh: Polarity

| Index | Sub index | Name | Type | Access | SAVE | PDO Mapping | Value Range | Default Value |
|-------|-----------|----------|------|--------|------|-------------|-------------|---------------|
| 607Eh | 0 | Polarity | U8 | RW | Yes | No | | 0 |

This object sets rotation direction of motor.

| Bit 7 | Bit 6 | Bit 5 | Bit 4 | Bit 3 | Bit 2 | Bit 1 | Bit 0 |
|-------------------|-------|-------|-------|-------|-------|-------|-------|
| Position Polarity | - | - | - | - | - | - | - |

Table 6.23: Polarity

Position related Objects will be multiplied by -1 when Position Polarity is 1.

6.5.19 Object 607Fh: Max profile velocity

| Index | Sub index | Name | Type | Access | SAVE | PDO Mapping | Value Range | Default Value |
|-------|-----------|----------------------|------|--------|------|-------------|-------------|---------------|
| 607Fh | 0 | Max profile velocity | U32 | RW | Yes | No | 1 ~ 2500000 | 2500000 |

This object sets Max. allowable velocity.

Whatever it receives value of velocity, controller does not move faster than Max Profile Velocity.

6.5.20 Object 6081h: Profile velocity

| Index | Sub index | Name | Type | Access | SAVE | PDO Mapping | Value Range | Default Value |
|-------|-----------|------------------|------|--------|------|-------------|-------------|---------------|
| 6081h | 0 | Profile velocity | U32 | RW | Yes | RxPDO | 1 ~ 2500000 | 10000 |

This object sets movement velocity under Profile Position Mode.

6.5.21 Object 6083h: Profile acceleration

| Index | Sub index | Name | Type | Access | SAVE | PDO Mapping | Value Range | Default Value |
|-------|-----------|----------------------|------|--------|------|-------------|-------------------|---------------|
| 6083h | 0 | Profile acceleration | U32 | RW | Yes | RxPDO | 1000 ~ 1000000000 | 1000000 |

This object sets acceleration under Profile Position Mode.
Unit is speed of increasing per second [pulse/s²].

6.5.22 Object 6084h: Profile deceleration

| Index | Sub index | Name | Type | Access | SAVE | PDO Mapping | Value Range | Default Value |
|-------|-----------|----------------------|------|--------|------|-------------|-------------------|---------------|
| 6084h | 0 | Profile deceleration | U32 | RW | Yes | RxPDO | 1000 ~ 1000000000 | 1000000 |

This object sets deceleration under Profile Position Mode.
Unit is speed of increasing per second [pulse/s²].

6.5.23 Object 6098h: Homing method

| Index | Sub index | Name | Type | Access | SAVE | PDO Mapping | Value Range | Default Value |
|-------|-----------|---------------|------|--------|------|-------------|-------------|---------------|
| 6098h | 0 | Homing method | I8 | RW | Yes | RxPDO | | 0 |

This object sets the method of sensor origin search under Homing Mode.
Homing Mode method is as follow.

| Value | Name |
|-------|---|
| 0 | No Mode |
| 17 | Homing on Negative Limit Switch |
| 18 | Homing on Positive Limit Switch |
| 24 | Homing on Origin Switch (Positive Direction, Negative Edge) |
| 28 | Homing on Origin Switch (Negative Direction, Positive Edge) |
| 35 | Set the current position origin |
| 37 | Set the current position origin and reset current position |

Table 6.24: Origin Search Method

Please refer to origin search method for detail operation, direction and velocity of each Homing Method.

6.5.24 Object 6099h: Homing speeds

| Index | Sub index | Name | Type | Access | SAVE | PDO Mapping | Value Range | Default Value |
|-------|-----------|--------------------------------|------|--------|------|-------------|-------------|---------------|
| 6099h | 0 | Number of entries | U8 | RO | No | No | | 2 |
| | 1 | Speed during search for switch | U32 | RW | Yes | RxPDO | 1 ~ 2500000 | 5000 |
| | 2 | Speed during search for zero | U32 | RW | Yes | RxPDO | 1 ~ 500000 | 1000 |

This object sets values of velocity under Homing Mode.
Speed during search for switch (Sub-Index 1) is the velocity is used for correspondent Switch. Please set appropriate velocity to sense correspondent Switch.
Speed during search for zero (Sub-Index 2) is the velocity is used for searching sensor origin after searching correspondent Switch.

6.5.25 Object 609Ah: Homing acceleration

| Index | Sub index | Name | Type | Access | SAVE | PDO Mapping | Value Range | Default Value |
|-------|-----------|---------------------|------|--------|------|-------------|-------------------|---------------|
| 609Ah | 0 | Homing acceleration | U32 | RW | Yes | RxPDO | 1000 ~ 1000000000 | 100000 |

This object sets Acc/Dec velocity under Homing Mode.
Unit is speed of increasing per second [pulse/s²].

6.5.26 Object 60B8h: Touch probe function

| Index | Sub index | Name | Type | Access | SAVE | PDO Mapping | Value Range | Default Value |
|-------|-----------|----------------------|------|--------|------|-------------|-------------|---------------|
| 60B8h | 0 | Touch probe function | U16 | RW | No | RxPDO | | 0000h |

This object sets and controls Touch Probe 1/2 operation.

| Bit | Value | Description |
|---------|-------|----------------------------------|
| 0 | 0 | Turn off Touch probe 1 function. |
| | 1 | Turn on Touch probe 1 function. |
| 1 | 0 | Sense 1st signal only. |
| | 1 | Sense signal continuously. |
| 2 ~ 3 | 0 | Sense origin signal. |
| | 1 | |
| | 2 | Sense signal set at 60D0h. |
| | 3 | - |
| 4 | 1 | Sense rising edge of 1 signal. |
| 5 | 1 | Sense falling edge of 1 signal. |
| 6 ~ 7 | 0 | - |
| 8 | 0 | Turn off Touch probe 2 function. |
| | 1 | Turn on Touch probe 2 function. |
| 9 | 0 | Sense 1st signal only. |
| | 1 | Sense signal continuously. |
| 10 ~ 11 | 0 | Sense origin signal. |
| | 1 | |
| | 2 | Sense signal set at 60D0h. |
| | 3 | - |
| 12 | 1 | Sense rising edge of 1 signal. |
| 13 | 1 | Sense falling edge of 1 signal. |
| 14 ~ 15 | 0 | - |

6.5.27 Object 60B9h: Touch probe status

| Index | Sub index | Name | Type | Access | SAVE | PDO Mapping | Value Range | Default Value |
|-------|-----------|--------------------|------|--------|------|-------------|-------------|---------------|
| 60B9h | 0 | Touch probe status | U16 | RO | No | TxPDO | | 0000h |

This object indicates status of Touch Probe 1/2.

| Bit | Value | Description |
|---------|-------|---|
| 0 | 0 | Halt status of Touch probe 1 function. |
| | 1 | Touch probe 1 function already turn on. |
| 1 | 0 | Rising edge of set signal has not sensed. |
| | 1 | Rising edge of set signal has sensed. |
| 2 | 0 | Falling edge of set signal has not sensed. |
| | 1 | Falling edge of set signal has sensed. |
| 3 ~ 5 | 0 | - |
| 6 ~ 7 | 0 ~ 3 | Indicates frequency of Touch probe 1 acknowledgement. |
| 8 | 0 | Halt status of Touch probe 2 function. |
| | 1 | Touch probe 2 function already turn on. |
| 9 | 0 | Rising edge of set signal has not sensed. |
| | 1 | Rising edge of set signal has sensed. |
| 10 | 0 | Falling edge of set signal has not sensed. |
| | 1 | Falling edge of set signal has sensed. |
| 11 ~ 13 | 0 | - |
| 14 ~ 15 | 0 ~ 3 | Indicates frequency of Touch probe 2 acknowledgement. |

Table 6.25: Definition of Touch probe status

6.5.28 Object 60BAh: Touch probe 1 positive value

| Index | Sub index | Name | Type | Access | SAVE | PDO Mapping | Value Range | Default Value |
|-------|-----------|------------------------------|------|--------|------|-------------|-------------|---------------|
| 60BAh | 0 | Touch probe 1 positive value | I32 | RO | No | TxPDO | | 0 |

This object indicates encoder position value sensed by Touch Probe 1 at rising edge.

6.5.29 Object 60BBh: Touch probe 1 negative value

| Index | Sub index | Name | Type | Access | SAVE | PDO Mapping | Value Range | Default Value |
|-------|-----------|------------------------------|------|--------|------|-------------|-------------|---------------|
| 60BBh | 0 | Touch probe 1 negative value | I32 | RO | No | TxPDO | | 0 |

This object indicates encoder position value sensed by Touch Probe 1 at falling edge.

6.5.30 Object 60BCh: Touch probe 2 positive value

| Index | Sub index | Name | Type | Access | SAVE | PDO Mapping | Value Range | Default Value |
|-------|-----------|------------------------------|------|--------|------|-------------|-------------|---------------|
| 60BCh | 0 | Touch probe 2 positive value | I32 | RO | No | TxPDO | | 0 |

This object indicates encoder position value sensed by Touch Probe 2 at rising edge.

6.5.31 Object 60BDh: Touch probe 2 negative value

| Index | Sub index | Name | Type | Access | SAVE | PDO Mapping | Value Range | Default Value |
|-------|-----------|------------------------------|------|--------|------|-------------|-------------|---------------|
| 60BDh | 0 | Touch probe 2 negative value | I32 | RO | No | TxPDO | | 0 |

This object indicates encoder position value sensed by Touch Probe 2 at falling edge.

6.5.32 Object 60C2h: Interpolation time period

| Index | Sub index | Name | Type | Access | SAVE | PDO Mapping | Value Range | Default Value |
|-------|-----------|---------------------------------|------|--------|------|-------------|-------------|---------------|
| 60C2h | 0 | Number of entries | U8 | RO | No | No | | 2 |
| | 1 | Interpolation time period value | U8 | RW | Yes | No | 0 ~ 255 | 2 |
| | 2 | Interpolation time index | I8 | RW | Yes | No | -4 ~ 1 | -3 |

This object indicates and sets cycle time using at synchronous control mode (for example : Cyclic Synchronous Position Mode)

$$\text{cycle time}[\text{sec}] = \text{Interpolation time period value} \times 10^{\text{Interpolation time index}}$$

Information

If uses DC mode for method of synchronization, cycle time ignores set value as above and automatically uses Sync0 cycle time.

**6.5.33 Object 60D0h: Touch probe source**

| Index | Sub index | Name | Type | Access | SAVE | PDO Mapping | Value Range | Default Value |
|-------|-----------|----------------------|------|--------|------|-------------|-------------|---------------|
| 60D0h | 0 | Number of entries | U8 | RO | No | No | | 2 |
| | 1 | Touch probe 1 source | U16 | RW | No | No | | 1 |
| | 2 | Touch probe 2 source | U16 | RW | No | No | | 1 |

If the value of Bit 2 ~ 3, 10 ~ 11 for Touch probe function (60B8h) as 2, uses input signal already set at this Object.

| Value | Input Source |
|-------|---------------|
| 1 | Origin Switch |
| 2 | User Input 1 |
| 3 | User Input 2 |

Table 6.26: Touch probe 1 source

| Value | Input Source |
|-------|---------------|
| 1 | Origin Switch |
| 2 | User Input 3 |
| 3 | User Input 4 |

Table 6.27: Touch probe 2 source

6.5.34 Object 60D5h: Touch probe 1 positive edge counter

| Index | Sub index | Name | Type | Access | SAVE | PDO Mapping | Value Range | Default Value |
|-------|-----------|-------------------------------------|------|--------|------|-------------|-------------|---------------|
| 60D5h | 0 | Touch probe 1 positive edge counter | U16 | RO | No | TxPDO | | 0 |

This object displays the number of times the rising edge of Touch Probe 1 is detected.

6.5.35 Object 60D6h: Touch probe 1 negative edge counter

| Index | Sub index | Name | Type | Access | SAVE | PDO Mapping | Value Range | Default Value |
|-------|-----------|-------------------------------------|------|--------|------|-------------|-------------|---------------|
| 60D6h | 0 | Touch probe 1 negative edge counter | U16 | RO | No | TxPDO | | 0 |

This object displays the number of times the falling edge of Touch Probe 1 is detected.

6.5.36 Object 60D7h: Touch probe 2 positive edge counter

| Index | Sub index | Name | Type | Access | SAVE | PDO Mapping | Value Range | Default Value |
|-------|-----------|-------------------------------------|------|--------|------|-------------|-------------|---------------|
| 60D7h | 0 | Touch probe 2 positive edge counter | U16 | RO | No | TxPDO | | 0 |

This object displays the number of times the rising edge of Touch Probe 2 is detected.

6.5.37 Object 60D8h: Touch probe 2 negative edge counter

| Index | Sub index | Name | Type | Access | SAVE | PDO Mapping | Value Range | Default Value |
|-------|-----------|-------------------------------------|------|--------|------|-------------|-------------|---------------|
| 60D8h | 0 | Touch probe 2 negative edge counter | U16 | RO | No | TxPDO | | 0 |

This object displays the number of times the falling edge of Touch Probe 2 is detected.

6.5.38 Object 60E3h: Supported homing methods

| Index | Sub index | Name | Type | Access | Constant Value |
|-------|-----------|------------------------------|------|--------|----------------|
| 60E3h | 0 | Number of entries | U8 | RO | 30 |
| | 1 | 1st supported homing method | I16 | RO | 1 |
| | 2 | 2nd supported homing method | I16 | RO | 2 |
| | 3 | 3rd supported homing method | I16 | RO | 7 |
| | 4 | 4th supported homing method | I16 | RO | 10 |
| | 5 | 5th supported homing method | I16 | RO | 11 |
| | 6 | 6th supported homing method | I16 | RO | 14 |
| | 7 | 7th supported homing method | I16 | RO | 17 |
| | 8 | 8th supported homing method | I16 | RO | 18 |
| | 9 | 9th supported homing method | I16 | RO | 24 |
| | 10 | 10th supported homing method | I16 | RO | 25 |
| | 11 | 11th supported homing method | I16 | RO | 28 |
| | 12 | 12th supported homing method | I16 | RO | 29 |
| | 13 | 13th supported homing method | I16 | RO | 33 |
| | 14 | 14th supported homing method | I16 | RO | 34 |
| | 15 | 15th supported homing method | I16 | RO | 35 |
| | 16 | 16th supported homing method | I16 | RO | 36 |
| | 17 | 17th supported homing method | I16 | RO | 37 |
| | 18 | 18th supported homing method | I16 | RO | -3 |
| | 19 | 19th supported homing method | I16 | RO | -4 |
| | 20 | 20th supported homing method | I16 | RO | -5 |
| | 21 | 21st supported homing method | I16 | RO | -6 |
| | 22 | 22nd supported homing method | I16 | RO | 0 |
| | . | . | | | |
| | 30 | 30th supported homing method | I16 | RO | 0 |

This object indicates lists of origin search methods supported by controller.

Information

Value of each index for Supported homing methods can be differentially indicates by product model or version.

**6.5.39 Object 60F4h: Following error actual value**

| Index | Sub index | Name | Type | Access | SAVE | PDO Mapping | Value Range | Default Value |
|-------|-----------|------------------------------|------|--------|------|-------------|-------------|---------------|
| 60F4h | 0 | Following error actual value | I32 | RO | No | TxPDO | | 0 |

This Object indicates value of position deviation.

Following error actual value = Position demand value (6062h) – Position actual value (6064h)

If the value of position deviation goes far from Following error window (6065h), Following Error will be generated.

6.5.40 Object 60FDh: Digital inputs

| Index | Sub index | Name | Type | Access | SAVE | PDO Mapping | Value Range | Default Value |
|-------|-----------|----------------|------|--------|------|-------------|-------------|---------------|
| 60FDh | 0 | Digital inputs | U32 | RO | No | TxPDO | | 0000 0000h |

This Object indicates status of input signals.

| | | | | | | | |
|--------|--------------|--------------|--------------|----------------|---------------|-----------------------|-----------------------|
| Bit 31 | Bit 30 | Bit 29 | Bit 28 | Bit 27 | Bit 26 | Bit 25 | Bit 24 |
| - | - | TQOFF2 | TQOFF1 | Z-Phase Signal | - | - | - |
| Bit 23 | Bit 22 | Bit 21 | Bit 20 | Bit 19 | Bit 18 | Bit 17 | Bit 16 |
| - | User Input 7 | User Input 6 | User Input 5 | User Input 4 | User Input 3 | User Input 2 | User Input 1 |
| Bit 15 | Bit 14 | Bit 13 | Bit 12 | Bit 11 | Bit 10 | Bit 9 | Bit 8 |
| - | - | - | - | - | - | - | - |
| Bit 7 | Bit 6 | Bit 5 | Bit 4 | Bit 3 | Bit 2 | Bit 1 | Bit 0 |
| - | - | - | - | - | Origin Switch | Positive Limit Switch | Negative Limit Switch |

Table 6.28: Definition of Digital Input

| Value | Definition |
|-------|-----------------|
| 0 | Input goes OFF. |
| 1 | Input goes ON. |

Table 6.29: Definition of Input Value

Bit 28, Bit 29 indicate the status of input signals used for the Safety function.

6.5.41 Object 60FEh: Digital outputs

| Index | Sub index | Name | Type | Access | SAVE | PDO Mapping | Value Range | Default Value |
|-------|-----------|-------------------|------|--------|------|-------------|-------------|---------------|
| 60FEh | 0 | Number of entries | U8 | RO | No | No | | 2 |
| | 1 | Physical outputs | U32 | RW | No | RxPDO | | 0000 0000h |
| | 2 | Bit mask | U32 | RW | No | No | | 003F 0000h |

Able to control User output through this Object and Brake.

| | | | | | | | |
|--------|--------|---------------|---------------|---------------|---------------|---------------|---------------|
| Bit 31 | Bit 30 | Bit 29 | Bit 28 | Bit 27 | Bit 26 | Bit 25 | Bit 24 |
| - | - | - | - | - | - | - | - |
| Bit 23 | Bit 22 | Bit 21 | Bit 20 | Bit 19 | Bit 18 | Bit 17 | Bit 16 |
| - | - | User Output 6 | User Output 5 | User Output 4 | User Output 3 | User Output 2 | User Output 1 |
| Bit 15 | Bit 14 | Bit 13 | Bit 12 | Bit 11 | Bit 10 | Bit 9 | Bit 8 |
| - | - | - | - | - | - | - | - |
| Bit 7 | Bit 6 | Bit 5 | Bit 4 | Bit 3 | Bit 2 | Bit 1 | Bit 0 |
| - | - | - | - | - | - | - | Set Brake |

Table 6.30: Definition of Physical outputs and Bit mask

Set Brake

Bit 0: Set Brake controls Brake output signal. Able to manually control Brake as set the value of Bit mask as 1.

| Value | Bit mask | Physical outputs |
|-------|----------------------|--------------------|
| 0 | | Brake Release (ON) |
| 1 | Brake Manual Control | Brake Engage (OFF) |

Table 6.31: Set Brake

Information

Under Operation enabled status, Brake always released (ON). Even set Bit mask as 1 and Physical output as 1, set values are ignored and Brake released.

**User Outputs**

Bit 16 ~ 21: Controls User outputs output signal. The value of Output is 'Bit mask' AND 'Physical output'.

| Value | Bit mask | Physical outputs |
|-------|----------------|------------------|
| 0 | Non-use output | Output OFF |
| 1 | Use output | Output ON |

Table 6.32: User Outputs

6.5.42 Object 6502h: Supported drive modes

| Index | Sub index | Name | Type | Access | Constant Value |
|-------|-----------|-----------------------|------|--------|----------------|
| 6502h | 0 | Supported drive modes | U32 | RO | 0000 00A1h |

This Object indicates Operation modes currently supported.
The meaning of each bit of this object is as follows.

| Bit 31 | ... | Bit 13 | Bit 12 | Bit 11 | Bit 10 | Bit 9 | Bit 8 |
|----------------------------------|----------------------------|-------------|--------|---------------------|-----------------------|--------------------------------|----------------------------------|
| - | ... | - | - | - | - | Cyclic Synchronous Torque Mode | Cyclic Synchronous Velocity Mode |
| Bit 7 | Bit 6 | Bit 5 | Bit 4 | Bit 3 | Bit 2 | Bit 1 | Bit 0 |
| Cyclic Synchronous Position Mode | Interpolated Position Mode | Homing Mode | - | Torque Profile Mode | Profile Velocity Mode | Velocity Mode | Profile Position Mode |

Table 6.33: Supported Drive Modes

Drive supports Profile Position Mode, Homing Mode and Cyclic Synchronous Position Mode.

6.6 Manufacture specific Object

6.6.1 Object 2001h: Sensors logics

| Index | Sub index | Name | Type | Access | SAVE | PDO Mapping | Value Range | Default Value |
|-------|-----------|----------------|------|--------|------|-------------|-------------|---------------|
| 2001h | 0 | Sensors logics | U8 | RW | Yes | No | | 00h |

This Object sets Logic of specific input signals.

| Bit 7 | Bit 6 | Bit 5 | Bit 4 | Bit 3 | Bit 2 | Bit 1 | Bit 0 |
|-------|-------|-------|-------|-------|-------|---------------------------|----------------------------|
| - | - | - | - | - | - | Limit Switch active logic | Origin Switch active logic |

Table 6.34: Sensor Logics

| Value | Definition |
|-------|-------------|
| 0 | Low active |
| 1 | High active |

Table 6.35: Definition of Logic Value

6.6.2 Object 2002h: Reverse limit direction

| Index | Sub index | Name | Type | Access | SAVE | PDO Mapping | Value Range | Default Value |
|-------|-----------|-------------------------|------|--------|------|-------------|-------------|---------------|
| 2002h | 0 | Reverse limit direction | U8 | RW | Yes | No | 0 ~ 1 | 0 |

This Object can set direction of Hardware Limit Switch.

It sets 1, IN/OUT connection of LIMIT+ and LIMIT- inputs will be exchanged.

Information

Please use for exchanging of LIMIT+ and LIMIT- input from IN/OUT connection when it is unable to change current wiring due to incorrect wiring of LIMIT+ and LIMIT- input signal,



6.6.3 Object 2003h: Limit stop method

| Index | Sub index | Name | Type | Access | SAVE | PDO Mapping | Value Range | Default Value |
|-------|-----------|-------------------|------|--------|------|-------------|-------------|---------------|
| 2003h | 0 | Limit stop method | U8 | RW | Yes | No | 0 ~ 4 | 0 |

This Object sets the method of stop once Hardware Limit Switch goes ON.

| Value | Definition (pp, hm) | Definition (csp) |
|-------|------------------------|------------------------|
| 0 | Quick Stop | Ignore (Does not stop) |
| 1 | Decelerated Stop | Ignore (Does not stop) |
| 2 | Ignore (Does not stop) | Ignore (Does not stop) |
| 3 | Quick Stop | Quick Stop |
| 4 | Decelerated Stop | Decelerated Stop |

Table 6.36: Stop Method

If the value is 0 or 1, it stops when Limit switch is detected in Profile Position Mode and Homing Mode only. It doesn't stop in Cyclic Synchronous Position Mode. If the value is 3 or 4, it stops even in Cyclic Synchronous Position Mode.

Information

The value of 3 or 4 are supported on devices with Software version (100Ah) 02.02.32 or higher.



Declaration ratio during decelerated stop follows Deceleration of correspondent operation mode. The deceleration ratio for Cyclic Synchronous Position Mode follows Object 201Bh: Limit Deceleration.

6.6.4 Object 2004h: External Encoder

| Index | Sub index | Name | Type | Access | SAVE | PDO Mapping | Value Range | Default Value |
|-------|-----------|-------------------|------|--------|------|-------------|-------------|---------------|
| 2004h | 0 | Number of entries | U8 | RO | No | No | | 3 |
| | 1 | Use Encoder | U8 | RW | Yes | No | 0 ~ 1 | 0 |
| | 2 | Encoder Multiply | U8 | RW | Yes | No | 0 ~ 2 | 2 |
| | 3 | Encoder Direction | U8 | RW | Yes | No | 0 ~ 1 | 0 |

This Objects set Ezi-STEP II EtherCAT to support an external encoder.

Information

This object is supported on devices with Software version (100Ah) 02.02.28 or higher.



Use Encoder

This object sets whether Ezi-STEP II EtherCAT reads the position of the external encoder or not.

| Value | Definition | Description |
|-------|-------------------------|--|
| 0 | Ignore external encoder | The value of Position actual value is the same as Position demand value. |
| 1 | Use external encoder | Position actual value displays the position of the external encoder. |

Table 6.37: Use Encoder

Encoder Multiply

This object sets the multiply of the external encoder.

| Value | Definition |
|-------|------------|
| 0 | x1 |
| 1 | x2 |
| 2 | x4 |

Table 6.38: Encoder Multiply

Encoder Direction

This object sets the direction of the external encoder.

| Value | Description |
|-------|-------------------------------|
| 0 | Multiply encoder value by 1. |
| 1 | Multiply encoder value by -1. |

Table 6.39: Encoder Direction

6.6.5 Object 2006h: Start speed

| Index | Sub index | Name | Type | Access | SAVE | PDO Mapping | Value Range | Default Value |
|-------|-----------|-------------|------|--------|------|-------------|-------------|---------------|
| 2006h | 0 | Start speed | U16 | RW | Yes | No | 1 ~ 50000 | 1 |

This Object sets initial velocity of motor[pps].

6.6.6 Object 2007h: Run current

| Index | Sub index | Name | Type | Access | SAVE | PDO Mapping | Value Range | Default Value |
|-------|-----------|-------------|------|--------|------|-------------|-------------|---------------|
| 2007h | 0 | Run current | U8 | RW | Yes | No | 5 ~ 15 | 10 |

This Object sets Run current of Motor. Unit is %.

Run current means that current value flowing through the motor while the motor is running, It is set based on the rated current of the motor. This value related to the torque during operation of the motor. If this value is high, torque during operation will increase. Therefore, if you think that the torque is insufficient, increase the value of this parameter to increase the torque.

$$\text{Run current}[\%] = \text{Value} \times 10$$

Information

- If Run current value is high, the heating temperature of a motor can be increased. So please be careful.
- The maximum setting of Run current(150%) is limited to 4[A]. Therefore, a motor(56mm, 60mm) that rated current value exceeds 2.7[A] will not increase as much as the set value even if the set value is raised.
- Run current is set automatically as load. Therefore use only when torque value during running is insufficient.



Information

This object can NOT be set while it's 'Operation Enabled' state. Please set after 'Operation Disable'. Please refer to [4.1 Drive Status Control](#).



6.6.7 Object 2008h: Boost current

| Index | Sub index | Name | Type | Access | SAVE | PDO Mapping | Value Range | Default Value |
|-------|-----------|---------------|------|--------|------|-------------|-------------|---------------|
| 2008h | 0 | Boost current | U8 | RW | Yes | No | 0 ~ 7 | 0 |

This Object sets the current value (Boost current) to be added when the motor accelerates or decelerates.

$$\text{Boost current}[\%] = \text{Value} \times 50$$

Boost current is applied proportional to the value of Run current. For example, if you use the EzM2-42XL (rated current: 1.2[A]), the Run current is 8 (80[%) and the Boost current is 1 (50[%%]), the control current value during acceleration or deceleration is as follow.

$$\begin{aligned} \text{Control Current value}[A] &= \text{Rated Current}[A] \times \text{Run current}[\%] \times (100[\%] + \text{Boost current}[\%]) \\ &= 1.2 \times 80[\%] \times (100[\%] + 50[\%]) \\ &= 1.2 \times 120[\%] \\ &= 1.44[A] \end{aligned}$$

Boost current is a setting that improves the accel./decel. characteristics by increasing the current supplied to the motor in case the accel./decel. time cannot be set sufficiently. Boost current only applies to acceleration and deceleration.

Information

- If Boost current value is high, the heating temperature of a motor can be increased. So please be careful.
- The control current is limited to 4[A] same as Run current. Therefore, a motor(56mm, 60mm) that rated current value exceeds 2.7[A] will not increase as much as the set value even if the set value is raised.



Information

This object can NOT be set while it's 'Operation Enabled' state. Please set after 'Operation Disable'. Please refer to [4.1 Drive Status Control](#).



6.6.8 Object 2009h: Stop current

| Index | Sub index | Name | Type | Access | SAVE | PDO Mapping | Value Range | Default Value |
|-------|-----------|--------------|------|--------|------|-------------|-------------|---------------|
| 2009h | 0 | Stop current | U8 | RW | Yes | No | 2 ~ 10 | 5 |

This object sets the Stop current when the motor is stopped and there is no load.

$$\text{Stop current}[\%] = \text{Value} \times 10$$

Stop current is applied proportional to the value of Run current. For example, if you use the EzM2-42XL (rated current: 1.2[A]), the Run current is 8 (80[%) and the Stop current is 5 (50[%%]), the control current value when the motor is stopped.

$$\begin{aligned} \text{Control Current value}[A] &= \text{Rated Current}[A] \times (\text{Run current}[\%] \times \text{Stop current}[\%]) \\ &= 1.2 \times (80[\%] \times 50[\%]) \\ &= 1.2 \times 40[\%] \\ &= 0.48[A] \end{aligned}$$

The drive adjusts the motor's drive current from Stop current to Run current according to the size of the load. This setting is used to reduce heat generation when the motor is stationary or when the load is light.

Information

If

| Index | Sub index | Name | Type | Access | SAVE | PDO Mapping | Value Range | Default Value |
|-------|-----------|--------------|------|--------|------|-------------|-------------|---------------|
| 2009h | 0 | Stop current | U8 | RW | Yes | No | 2 ~ 10 | 5 |

value is high, the heating temperature of a motor can be increased. So please be careful.

Information

This object can NOT be set while it's 'Operation Enabled' state. Please set after 'Operation Disable'. Please refer to [4.1 Drive Status Control](#).

6.6.9 Object 200Ah: Motor number

| Index | Sub index | Name | Type | Access | SAVE | PDO Mapping | Value Range | Default Value |
|-------|-----------|--------------|------|--------|------|-------------|-------------|---------------|
| 200Ah | 0 | Motor number | U16 | RO | No | No | | |

This Object indicates number of motor currently set.

6.6.10 Object 200Ch: Reference resolution

| Index | Sub index | Name | Type | Access | SAVE | PDO Mapping | Value Range | Default Value |
|-------|-----------|----------------------|------|--------|------|-------------|--------------|---------------|
| 200Ch | 0 | Reference resolution | U32 | RW | Yes | No | 500 ~ 100000 | 10000 |

This Object sets required number of Pulse to rotate 1 revolution of motor.

Information

Recommend to set same or lower value of Encoder resolution (2005h). In case of setting higher value than Encoder resolution, certain value of Following error can be generated.

Information

This object can NOT be set while it's 'Operation Enabled' state. Please set after 'Operation Disable'. Please refer to [4.1 Drive Status Control](#).

6.6.11 Object 200Fh: Encoder filter time

| Index | Sub index | Name | Type | Access | SAVE | PDO Mapping | Value Range | Default Value |
|-------|-----------|---------------------|------|--------|------|-------------|-------------|---------------|
| 200Fh | 0 | Encoder filter time | U8 | RW | Yes | No | 0 ~ 1 | 0 |

This object can set the Filter to the Encoder input that is input to the controller.

| Value | Definition |
|-------|---------------------|
| 0 | Default value |
| 1 | Apply 500 ns Filter |

Table 6.40: Encoder Filter Time

Information

This object can NOT be set while it's 'Operation Enabled' state. Please set after 'Operation Disable'. Please refer to [4.1 Drive Status Control](#).

Information

This object is supported on devices with Software version (100Ah) 02.02.23 or higher.

**6.6.12 Object 2010h: Brake delay**

| Index | Sub index | Name | Type | Access | SAVE | PDO Mapping | Value Range | Default Value |
|-------|-----------|-------------|------|--------|------|-------------|-------------|---------------|
| 2010h | 0 | Brake delay | U16 | RW | Yes | No | 0 ~ 1000 | 200 |

This Object sets timing up to Brake release after Enable commands.

Information

Ezi-STEPII EtherCAT 86 model does not support Brake delay Object.

**6.6.13 Object 2011h: Digital input levels**

| Index | Sub index | Name | Type | Access | SAVE | PDO Mapping | Value Range | Default Value |
|-------|-----------|----------------------|------|--------|------|-------------|-------------|---------------|
| 2011h | 0 | Digital input levels | U16 | RW | Yes | No | | 0000h |

This Object sets Level of Digital inputs of User input.

| Bit | Description |
|--------|----------------------------|
| 0 | Set Level of User Input 1. |
| 1 | Set Level of User Input 2. |
| 2 | Set Level of User Input 3. |
| 3 | Set Level of User Input 4. |
| 4 | Set Level of User Input 5. |
| 5 | Set Level of User Input 6. |
| 6 | Set Level of User Input 7. |
| 7 ~ 15 | - |

6.6.14 Object 2012h: Digital output levels

| Index | Sub index | Name | Type | Access | SAVE | PDO Mapping | Value Range | Default Value |
|-------|-----------|-----------------------|------|--------|------|-------------|-------------|---------------|
| 2012h | 0 | Digital output levels | U16 | RW | Yes | No | | 0000h |

This Object sets Level of Digital outputs of User output.

| Bit | Description |
|--------|-----------------------------|
| 0 | Set Level of User Output 1. |
| 1 | Set Level of User Output 2. |
| 2 | Set Level of User Output 3. |
| 3 | Set Level of User Output 4. |
| 4 | Set Level of User Output 5. |
| 5 | Set Level of User Output 6. |
| 6 ~ 15 | - |

6.6.15 Object 201Bh: Limit Deceleration

This object sets deceleration ratio applied in deceleration stop in Cyclic Synchronous Position Mode.

| Index | Sub index | Name | Type | Access | SAVE | PDO Mapping | Value Range | Default Value |
|-------|-----------|--------------------|------|--------|------|-------------|-------------------|---------------|
| 201Bh | 0 | Limit Deceleration | U32 | RW | Yes | No | 1000 ~ 1000000000 | 1000000 |

Unit is speed of increasing per second [pulse/s²].

Information

This object is supported on devices with Software version (100Ah) 02.02.32 or higher.



6.6.16 Object 2020h: Error code history setting

| Index | Sub index | Name | Type | Access | SAVE | PDO Mapping | Value Range | Default Value |
|-------|-----------|------------------------------|------|--------|------|-------------|-------------|---------------|
| 2020h | 0 | Number of entries | U8 | RO | No | No | | 3 |
| | 1 | Function | U32 | RW | No | No | | 0 |
| | 2 | Interval for same Error Code | U32 | RW | Yes | No | 0 ~ 3600000 | 0 |
| | 3 | Interval for last Error Code | U32 | RW | Yes | No | 0 ~ 3600000 | 0 |

This object can delete the record of Error code history or adjust the recording time.

Information

This object is supported on devices with Software version (100Ah) 02.02.23 or higher.



Function

The Function can delete the record of Error code history. If you enter '00726C63h' value in the Function, all the history in the list is initialized.

Interval for same Error Code

If the same kind of Error code occurs again within the set time, the corresponding Error code is not recorded. The unit of setting value is ms.

If the value is set to 0, all occurrences of Error code are recorded without any restrictions.

Interval for last Error Code

If an error occurs again within the set time, the corresponding Error code is not recorded. The unit of setting value is ms.

If the value is set to 0, all occurrences of Error code are recorded without any restrictions.

6.6.17 Object 2021h: Error code history

| Index | Sub index | Name | Type | Access | SAVE | PDO Mapping | Value Range | Default Value |
|-------|-----------|------------------------|------|--------|------|-------------|-------------|---------------|
| 2021h | 0 | Number of entries | U8 | RO | No | No | | 30 |
| | 1 | Latest error code | U16 | RO | No | No | | 0 |
| | 2 | 2nd latest error code | U16 | RO | No | No | | 0 |
| | 3 | 3rd latest error code | U16 | RO | No | No | | 0 |
| | 4 | 4th latest error code | U16 | RO | No | No | | 0 |
| | . | . | | | | | | |
| | 30 | 30th latest error code | U16 | RO | No | No | | 0 |

Displays the most recent Error code list. The maximum number of Error code that can be stored is 30. The list of Error code stored in Error code history will not be erased even if the controller is powered off. Please refer to the function of Error code history setting to initialize the list of Error code history.

Information

This object is supported on devices with Software version (100Ah) 02.02.23 or higher.



6.6.18 Object 2025h: Lifetime Record

| Index | Sub index | Name | Type | Access | SAVE | PDO Mapping | Value Range | Default Value |
|-------|-----------|---------------------|------|--------|------|-------------|-------------|---------------|
| 2025h | 0 | Number of entries | U8 | RO | No | No | | 10 |
| | 1 | LTR Operating Time | U32 | RO | No | No | | 0 |
| | 2 | LTR Enable Time | U32 | RO | No | No | | 0 |
| | 3 | LTR Rotating Count | U32 | RO | No | No | | 0 |
| | 4 | POR Operating Time | U32 | RO | No | No | | 0 |
| | 5 | POR Enable Time | U32 | RO | No | No | | 0 |
| | 6 | POR Rotating Count | U32 | RO | No | No | | 0 |
| | 7 | LTR2 Operating Time | U32 | RO | No | No | | 0 |
| | 8 | LTR2 Enable Time | U32 | RO | No | No | | 0 |
| | 9 | LTR2 Rotating Count | U32 | RO | No | No | | 0 |
| | 10 | LTR2 Function | U32 | RW | No | No | | 0 |

This Object shows the time the controller has operated and the distance traveled. For example, if the controller operates as follows, each value is as follows:

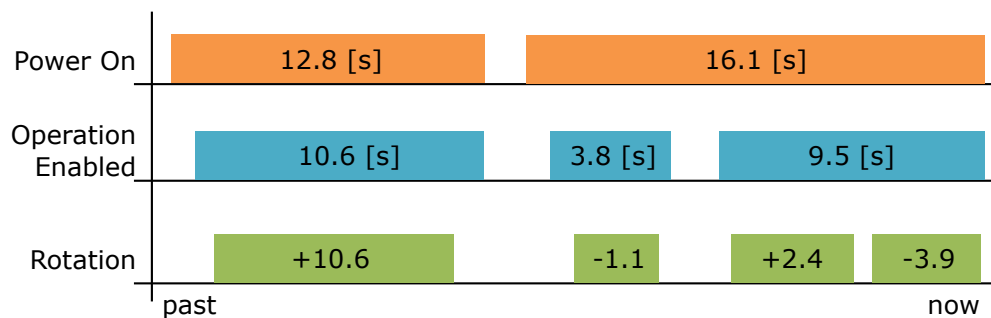

| Item | Value | Details |
|--------------------|----------|---------------------------------|
| LTR Operating Time | 28 [s] | $12 + 16.1 = 28.1$ |
| LTR Enable Time | 23 [s] | $10 + (3.8 + 9.5) = 23.3$ |
| LTR Rotating Count | 17 [rev] | $10 + (1.1 + 2.4 + 3.9) = 17.4$ |
| POR Operating Time | 16 [s] | 16.1 |
| POR Enable Time | 13 [s] | $3.8 + 9.5 = 13.3$ |
| POR Rotating Count | 7 [rev] | $1.1 + 2.4 + 3.9 = 7.4$ |

Table 6.41: Lifetime Record

Information

This object is supported on devices with Software version (100Ah) 02.03.36 or higher.



LTR Operating Time

It displays the total time it has been powered on and operated for a lifetime (Since the product was shipped).

The unit is [s]. Times below the decimal point are discarded when the controller is power off.

LTR Enable Time

It displays the total time it has been powered on and the drive is the Operation enabled state for a lifetime (Since the product was shipped).

The unit is [s]. Times below the decimal point are discarded when the controller is power off.

LTR Rotating Count

It displays the total number of revolutions the motor has rotated through the command for a lifetime (Since the product was shipped).

The unit is [rev] and the number of revolutions below the decimal point is discarded when the controller is power off.

POR Operating Time

It displays the time [s] that has elapsed after the controller was recently powered up.

POR Enable Time

It displays the time [s] the drive has been in Operation Enabled after the controller was recently powered up.

POR Rotating Count

It displays the number of revolutions the motor has rotated through the command after the controller was recently powered up.

LTR2 Operating Time

Same as Sub-Index 1 - LTR Operating Time, it displays the total time it has been powered on and operated. It can be initialized through the LTR2 Function.

LTR2 Enable Time

Same as Sub-Index 2 - LTR Enable Time, it displays the total time it has been powered on and the drive is the Operation enabled state. It can be initialized through the LTR2 Function.

LTR2 Rotating Count

Same as Sub-Index 3 - Rotating Count, it displays the total number of revolutions the motor has rotated through the command. It can be initialized through the LTR2 Function.

LTR2 Function

By writing 00726C63h in LTR2 Function object, LTR2 Operating Time, LTR2 Enable Time, LTR2 Rotating Count can be initialized.

When the initialization command is written, the values of the above three objects are immediately cleared to 0, and the data is accumulated again from that time.

6.6.19 Object 2030h: Advanced settings

| Index | Sub index | Name | Type | Access | SAVE | PDO Mapping | Value Range | Default Value |
|-------|-----------|--|------|--------|------|-------------|-------------|---------------|
| 2030h | 0 | Number of entries | U8 | RO | No | No | | 5 |
| | 1 | Automatic recovery from communication error | U8 | RW | Yes | No | 0 ~ 1 | 0 |
| | 2 | Disable Automatic transition 2 | U8 | RW | Yes | No | 0 ~ 1 | 0 |
| | 3 | Config Internal Limit Active bit | U8 | RW | Yes | No | 0 ~ 1 | 0 |
| | 4 | Enable Packet Delay Compensation | U8 | RW | Yes | No | 0 ~ 1 | 1 |
| | 5 | Transit to Fault state when Safety activated | U8 | RW | Yes | No | 0 ~ 1 | 0 |

Information

This object is supported on devices with Software version (100Ah) 02.02.30 or higher.



Automatic Recovery from Communication Error

This object can set 'EtherCAT communication error (7500h)' to be clear when EtherCAT communication status is activated again. If the value is set to 1, the 'EtherCAT communication error (7500h)' is automatically cleared when the state of EtherCAT State Machine changes from Safe-Operational to Operational.

Disable Automatic transition 2

This object can set whether 'Transition 2' of Drive State Machine occurs automatically or not. If the value is set to 1, Transition 2 will not occur automatically, but rather through the 'Shutdown' command.

Information

This object is supported on devices with Software version (100Ah) 02.02.32 or higher.

**Config Internal Limit Active bit**

This object can change how to operate Status word - bit 11: Internal Limit Active. If the value is set to 1, the Internal Limit Active bit also displays the H/W Limit Switch status.

Information

This object is supported on devices with Software version (100Ah) 02.02.32 or higher.

**Enable Packet Delay Compensation**

In Cyclic Synchronous Position Mode, the EtherCAT master sends the position to which the drive should go in every cycle, and the drive moves to the position in the DC Sync Event. If the EtherCAT master sends the packet later than the DC Sync Event, the drive received the position information to go in this cycle in the next cycle. This causes the motor to repeat the action of stopping for a short time and moving at double speed. That is, the vibration of the motor occurs due to the delay of the packet. 'Enable Packet Delay Compensation' object is a function to reduce the vibration of the motor when the packet sent by the EtherCAT master is delayed in Cyclic Synchronous Position Mode. If the value is set to 1, the 'Enable Packet Delay Compensation' function is enabled.

Information

This object is supported on devices with Software version (100Ah) 02.03.48 or higher.

**Transit to Fault state when Safety activated**

This object can be set to notify as an alarm when the Safety function is activated. If the value is set to 1, an alarm (Error Code FF45h) occurs when Safety function is activated by turning the TQOFF inputs OFF.

This error can be cleared with the Fault reset command.

Information

This object is supported on devices with Software version (100Ah) 02.02.51 or higher.

**6.6.20 Object 2040h: Safety Mode**

| Index | Sub index | Name | Type | Access | SAVE | PDO Mapping | Value Range | Default Value |
|-------|-----------|-----------------------|------|--------|------|-------------|-------------|---------------|
| 2040h | 0 | Number of entries | U8 | RO | No | No | | 4 |
| | 1 | Safety Status | U8 | RO | No | No | | 0 |
| | 2 | Control Safety Input | U8 | RW | Yes | No | 0 ~ 2 | 0 |
| | 3 | Control Safety Output | U8 | RW | Yes | No | 0 ~ 1 | 0 |
| | 4 | Safety IO Logics | U8 | RW | Yes | No | | 00h |

This object set the Safety Function and indicates the status.

Information

This object is supported on devices with Software version (100Ah) 02.02.31 or higher.

**Safety Status**

This object indicates the status of Safety Function.

| Bit 7 | Bit 6 | Bit 5 | Bit 4 | Bit 3 | Bit 2 | Bit 1 | Bit 0 |
|-------|-------|--------|--------|-------|---------------------|--------------|--------|
| - | - | TQOFF2 | TQOFF1 | - | Acknowledge Request | Input Status | Enable |

Table 6.42: Safety Status

Bit 0 - Enable: Safety Function is ready. It indicates that the value of Control Safety Input is set to a value other than 0, so that Digital In1, Digital In2 input signals are operate as TQOFF Input.

Bit 1 - Inputs Status: Some inputs assigned as TQOFF Input are ON. Inputs Status is ON when TQOFF1 or TQOFF2 is ON. Inputs Status is OFF when TQOFF1 and TQOFF2 are OFF.

Bit 2 - Acknowledge Request: TQOFF Inputs are OFF but the Shutdown command was not received yet. it's ON when TQOFF Inputs are OFF after Safety Function is activated. It can be removed by sending the Shutdown command in Control word.

Bit 4 - TQOFF1: The input assigned as TQOFF1 is OFF.

Bit 5 - TQOFF2: The input assigned as TQOFF2 is OFF.

Control Safety Input

This object can config the inputs of Safety Function.

Inputs of I/O Connector can be assign for Safety Function by setting Control Safety Input.

If Control Safety Input is set to 0, Safety Function using Digital Inputs is disabled.

| Value | Description |
|-------|--|
| 0 | Disable the Safety Function. |
| 1 | Use Digital In1 as Safety Function. Digital In1 is assigned to the TQOFF1 and TQOFF2. |
| 2 | Use Digital In1 and Digital In2 as Safety Function. Digital In1 is assigned to the TQOFF1 and Digital In2 is assigned to the TQOFF2. |

Table 6.43: Control Safety Input

When Safety Function is enabled, the bit 28 (TQOFF1), bit 29 (TQOFF2) of Digital inputs indicate the status of Safety Inputs.

Control Safety Output

This object can config the output of Safety Function.

if Control Safety Output is set to 1, it can be checked whether the TQOFF Inputs are ON or OFF by Digital Out1.

| Value | Description |
|-------|--|
| 0 | - |
| 1 | Use the Digital Out1 as Safety Function. Digital Out1 output becomes ON when assigned input at TQOFF Input is OFF. |

Table 6.44: Control Safety Output

When Digital Out1 was assigned to the Safety Function, the value of bit 16 of Object 60FEh: Digital outputs that controls the output of Digital Out1 is ignored.

Safety IO Logics

This object can config the active level of the Safety Input and Safety Output.

| Bit 7 | Bit 6 | Bit 5 | Bit 4 | Bit 3 | Bit 2 | Bit 1 | Bit 0 |
|-------|-------|-------|-------|-------|-------|----------------------|--------------------|
| - | - | - | - | - | - | Safety Out-put Logic | Safety Input Logic |

Table 6.45: Safety IO Logics

The bit 0 of Safety IO Logics is Safety Input Logic. when the value is 0, if the photocoupler of the assigned inputs as Safety Input is [OFF : Non-conduction], it recognized as OFF and the Safety Function is activated.

when the value is 1, if the photocoupler of the assigned inputs as Safety Input is [ON : Conduction], it recognized as OFF and the Safety Function is activated.

| Value | Definition | Photocoupler status | Input status |
|-------|-------------|----------------------|--------------|
| 0 | Low active | ON : Conduction | ON |
| | | OFF : Non-conduction | OFF |
| 1 | High active | ON : Conduction | OFF |
| | | OFF : Non-conduction | ON |

Table 6.46: Safety Input Logic

The bit 1 of Safety IO Logics is Safety Output Logic. when the value is 0, if Safety Output is ON, the photocoupler of the assigned output as Safety Output is [ON : Conduction].

when the value is 1, if Safety Output is ON, the photocoupler of the assigned output as Safety Output is [OFF : Non-conduction].

| Value | Definition | Output status | Photocoupler status |
|-------|-------------|---------------|----------------------|
| 0 | Low active | ON | ON : Conduction |
| | | OFF | OFF : Non-conduction |
| 1 | High active | OFF | ON : Conduction |
| | | ON | OFF : Non-conduction |

Table 6.47: Safety Output Logic

Changelog

| Date | Revision | Changes |
|------------|-----------|---|
| 2015-06-09 | Rev.01.03 | Document updated. |
| 2015-07-22 | Rev.01.04 | Update Object 1011h: Restore default parameters. Add 'Info' boxes in '6.6 Manufacture specific Object'. |
| 2015-08-03 | Rev.01.05 | Document updated |
| 2015-12-28 | Rev.01.06 | Correct homing method -4 and -5 description error in '4.6.4 Homing Method List' |
| 2016-02-05 | Rev.01.07 | Add Object 2014h: Homing Torque Ratio. |
| 2016-04-21 | Rev.01.08 | Update Object 60E3h: Supported homing methods. Update Object 2001h: Sensors logics. |
| 2016-11-23 | Rev.01.09 | Update '4.8.4 ORIGIN and LIMIT Input'. |
| 2016-12-21 | Rev.01.10 | Deleted 'Input voltage error' from '4.2 Error Code'. |
| 2017-02-13 | Rev.01.11 | Add 'Distributed Clock' in the '1.3 EtherCAT specification'. |
| 2017-04-03 | Rev.01.12 | Fix temperature value of 'Over temperature error' in '4.2 Error Code'. |
| 2017-06-15 | Rev.01.14 | Add Object 2016h: Internal Load Ratio. Add Object 2018h: Internal Current Value. Update 'Figure 4.2: CSP Mode Objects', 'Figure 4.3: Profile Position Mode'. Update Object 6064h: Position actual value. Update 'Table 4.12: Profile Position Mode of Control Word'. Update 'Table 4.24: Homing Method List'. Update 'Table 4.5: Error code Lists'. Update object table in Object 60E3h: Supported homing methods. |
| 2017-06-26 | Rev.15 | Add 'Changelog'. |
| 2017-09-26 | Rev.16 | Update Object 605Dh: Halt option code. Update Object 2003h: Limit stop method. Update Object 607Dh: Software position limit. Update the EtherCAT minimum cycle time to 250us. Update the PDO Mapping information of Homing Mode related objects. |
| 2018-04-13 | Rev.17 | Update the Data Type of Object 60D0h: Touch probe source. Add Object 200Fh: Encoder filter time. Add Object 2020h: Error code history setting. Add Object 2021h: Error code history. Add Object 2031h: Encoder count error. Add new error code: E-070. Fixed typo. |
| 2018-06-19 | Rev.18 | Delete '3.2.3 Module'. Update Object 2018h: Internal Current Value. |
| 2018-08-07 | Rev.19 | Update Object 606Ch: Velocity actual value. Add Object 606Bh: Velocity demand value. |
| 2018-11-22 | Rev.20 | Update Object 6065h: Following error window, Object 6067h: Position window. Update 'Error Code Lists'. Add Voltage Limit of Back-EMF. Add Object 2004h: External Encoder. |
| 2019-02-25 | Rev.21 | Add Object 2030h: Advanced settings |
| 2019-04-19 | Rev.22 | Update Specifications. |
| 2019-05-30 | Rev.23 | Add '4.9 Safety Function'. Add Object 2040h: Safety Mode. Update Object 607Eh: Polarity. Fixed typo. |
| 2019-06-05 | Rev.24 | Update '4.2 Error Code'. |
| 2019-09-19 | Rev.25 | Update Object 6041h: Status word - Internal Limit Active. Update Object 2003h: Limit stop method. Update Object 2030h: Advanced settings. Update Object 607Dh: Software position limit. Add Object 201Bh: Limit Deceleration. |
| 2019-12-16 | Rev.26 | 'Z-Phase' signal added in the Object 60FDh: Digital inputs. More error codes added at the Object 603Fh: Error code. |
| 2020-02-24 | Rev.27 | Add Object 2025h: Lifetime Record. Update object table in Object 10F1h: Error settings. |
| 2020-07-02 | Rev.30 | Rename the 'Part Numbering' section to 'Model Naming' |
| 2020-07-21 | Rev.31 | Add new error codes in '4.2 Error Code'. Fix the count of User I/O. |
| 2020-09-15 | Rev.32 | Add Ezi-STEP II EtherCAT 86 model. Fixed a code error of 'Network Initialization Error'. |
| 2021-02-02 | Rev.33 | Fixed timing chart error of '4.9 Safety Function' Fixed the default value of Object 10F1h: Error settings. Fixed the error of Current consumption value of 'Brake Signal output signal'. Update object table in Object 10F3h: Diagnosis history. Update Object 2018h: Internal Current Value. Fixed the error of the ambient temperature value in '2.1 Precautions of Installation'. |
| 2021-08-06 | Rev.34 | Add USB connector descriptions. |

| Date | Revision | Changes |
|------------|----------|---|
| | | Update the terminology of the EtherCAT communication phase according to the EtherCAT standard. Update Object 2025h: Lifetime Record. Update the value table of Object 605Ah: Quick stop option code. Update the description of Object 2009h: Stop current. |
| 2021-11-02 | Rev.35 | Update the description of Object 2030h: Advanced settings. Update the descriptions of Control word, Status word in '4. CiA402 Drive Profile'. Update the table of '4.2 Error Code'. |
| 2022-03-08 | Rev.36 | Update the description of Object 10F1h: Error settings and Object 10F3h: Diagnosis history. Uniform hexadecimal number representation. Update the table of '4.2 Error Code'. |
| 2022-03-31 | Rev.37 | Update the description of Object 2030h: Advanced settings. Update the description of Position control gain. Update the Timing chart image in the Safety Function. Update the descriptions of Object 2007h: Run current, Object 2009h: Stop current, Object 2008h: Boost current. Update the description of Object 60F4h: Following error actual value. Update the description of Object 200Fh: Encoder filter time. Update the description of Object 6040h: Control word. |

- It is prohibited to copyright or replication of the part or whole of user manual without permission.
- When user manual is needed due to damage or loss, please contact Head Quarter of Fastech or our distributors.
- The user manual can be changed without pre-notification in order to reflect improvement or change of the product specifications and for the improvement of user manual.

- Ezi-STEP II is registered trademark of FASTECH Co., Ltd. which is registered in Korea.
- EtherCAT® is registered trademark and patented technology, licensed by Beckhoff Automation GmbH, Germany.
- Extra name of system and product on this manual is each company of brand or trademark.



Fast, Accurate, Smooth Motion

FASTECH Co., Ltd.

Rm#1202, 401-dong, Bucheon Techno-Park,
655, Pyeongcheon-ro, Bucheon-si Gyeonggi-do,
Republic of Korea (Zip:14502)
TEL : +82-32-234-6300 FAX : +82-32-234-6302
E-mail : fastech@fastech.co.kr
Homepage : www.fastech.co.kr



Copyright © 2014–2022 FASTECH Co., Ltd.
All Rights Reserved.
2022-03-31
Rev.37